

**uvex**

# uvex safety gloves 2023



# protecting planet

To help raise awareness of its commitment to achieving increased sustainability, uvex has developed the **protecting planet** icon.

For uvex, **protecting planet** is more than a label. Based on the brand claim, **protecting people**, our sustainable approach integrates three core interlinked pillars – **ecology, economy** and **social responsibility**, that are incorporated throughout the business to improve our sustainability performance.

This explains the comprehensive audit, measurement and evaluation management process uvex undertakes along the entire value chain to ensure its products are as sustainable as possible.



uvex Bamboo TwinFlex®  
D xg planet

The **uvex Bamboo TwinFlex® D xg planet** is an example of the **planet series** product system.



**protecting planet**

by using bio-based material //  
by using recycled material //  
by maximum reduction of pollutants

By using bamboo viscose uvex is utilising a renewable raw material and recycled polyamide. Together, these sustainable materials account for 45 percent of the material used. The gloves also offer greater protection to the health of the wearer than stipulated by REACH regulations as they comply with the uvex list of banned substances and the skin compatibility has been dermatologically approved by the proDERM institute.



**protecting planet**

by using environmentally-friendly packaging

The glove packaging has been minimised significantly. Paper wrap is used instead of rubber bands to secure bundles. Polyester bags have not been used by uvex in its glove packaging for over 11 years.



**protecting planet**

by having a CO<sub>2</sub> neutral production

uvex safety gloves is certified according to both Environmental Management ISO 14001 and Energy Management ISO 50001 and has CO<sub>2</sub>-neutral production rating based on direct emissions from production. To achieve this, we have been sourcing electricity from 100 percent renewable energy sources since 2014, and through the certified green electricity product we have been promoting the construction of new renewable energy plants in the region. We use green gas to operate the highly efficient CHP plant at our site, thereby offsetting the CO<sub>2</sub> emissions produced by gas combustion processes. Through carbon offsetting, we invest exclusively in climate protection projects that are certified by internationally recognised quality standards (Gold Standard or VCS (Verified Carbon Standard)) and thereby promote, for example, the construction of new plants in India for the generation of solar and wind power.



# Innovative safety gloves “Made in Germany”

Manufacturing and technology expertise



Video



## uvex hand protection centre of expertise in Lüneburg

A fully integrated development process, state-of-the-art robot-controlled plant technology and strict production controls guarantee that our safety gloves are of first-class quality. Production in Germany ensures sustainable, resource-saving production and short distances from manufacturer to end user.

### Sustainable production:

- CO2-neutral production
- Solvents and plasticisers not used in production
- Sustainable environmental and energy management (ISO 14001/ISO 50001)
- Made locally in Germany



### Social responsibility:

- Full implementation of the ILO standard
- Continuous social audits at partner companies (uvex social standard)
- Social engagement with a focus on disadvantaged children



### Health:

- Over-compliance with REACH regulations on eliminating harmful substances
- Ongoing analysis of almost 200 critical substances (uvex harmful substances standard)
- Certified in line with Oeko-Tex® Standard 100
- DERMA-certified free from allergenic substances



### Comfort:

- Extremely comfortable thanks to the use of breathable natural and functional fibres
- Optimum tactile feel thanks to an ergonomic fit
- Natural feel against the skin



**MADE IN GERMANY**

Quality management

Energy management

Environmental management

# Extensive know-how is part of our service

Service expertise



## We know exactly what you want.

Our expertise is available for you at all times which forms the basis of our on-site. Risk-hazard analysis service: Our hand protection specialists work with you to determine which safety gloves are best suited to your individual requirements. Seminars, laboratory analyses and online tools round off our service portfolio.

---

### Fully integrated development processes

- own yarn/liner manufacturing
- own compounding (blending)
- specially developed moulding and process technology
- innovative coating technology
- development of customer-specific solutions
- technical modifications to existing products (e.g. thermal lining)
- individual production (e.g. gloves for disabled people)

---

### Consultation / training / application technology

- on-site consultation from uvex product specialists
- practical hand protection seminars (uvex academy)
- plant and laboratory tours for customers
- cooperation with scientific institutes
- measurement and analysis service in own laboratories
  - mechanical standard test in accordance with EN 388
  - permeation tests in accordance with EN 374
  - special tests (e.g. antistatic/grip measurement/ climate test)
- individual certifications (e.g. for ingredients, coating compatibility, food product suitability)

---

### Information / e-services

- Chemical Expert System (CES)
- designer glove plan
- online glove navigator
- online product data sheets
- online declaration of conformity

For further information, please visit:  
[www.uvex-safety.de/usglfilm](http://www.uvex-safety.de/usglfilm)

# Safety Gloves

## Mechanical Risks / Special risks

 Precision work

uvex phynomic

														
Page 16	Page 17	Page 17	Page 17	Page 18	Page 18	Page 18	Page 19	Page 19	Page 20	Page 20	Page 21	Page 21	Page 21	Page 21
uvex phynomic airLite A ESD	uvex phynomic foam	uvex phynomic allround	uvex phynomic XG	uvex phynomic x-foam HV	uvex phynomic wet	uvex phynomic wet plus	uvex phynomic pro	uvex phynomic pro 2	uvex phynomic lite	uvex phynomic lite w	uvex rubipor XS	uvex rubipor XS	uvex rubipor XS	uvex rubipor XS

uvex athletic

			
Page 21	Page 22	Page 22	Page 22
uvex athletic allround	uvex athletic lite	uvex athletic lite ESD	uvex athletic lite dry

uvex unilite

	
Page 23	Page 23
uvex unilite 6605	uvex unilite 7700

uvex unipur

					
Page 23	Page 24	Page 24	Page 24	Page 25	Page 25
uvex unipur 6634	uvex unipur 6630	uvex unipur 6631	uvex unipur 6639	uvex unipur carbon	uvex unipur carbon FT

uvex unigrip

	
Page 25	Page 25
uvex unigrip 6624	uvex unigrip 6620

 Allround

uvex profi

					
Page 26	Page 26	Page 26	Page 27	Page 27	Page 27
uvex contact ergo ENB20C	uvex profi ergo ENB20A	uvex profi ergo ENB20	uvex profi ergo XG20A	uvex profi ergo XG	uvex glove clip

 Heavy Duty

			
Page 28	Page 28	Page 28	Page 28
uvex rubiflex	uvex unilite 7710 F	uvex compact NB27E	uvex compact NB27H

 Heat protection

		
Page 29	Page 29	Page 29
uvex nk	uvex k-basic extra	uvex profatherm

 Cold protection

uvex unilite thermo

			
Page 30	Page 30	Page 30	Page 30
uvex unilite thermo	uvex unilite thermo plus	uvex unilite thermo HD	uvex unilite thermo plus cut c

 Working on live parts

	
Page 31	Page 31
uvex power protect V1000	uvex arc protect g1

# Safety Gloves

## Cut protection

uvex D500 / uvex C500				uvex C500						uvex C300		
Page 35	Page 36	Page 36	Page 37	Page 37	Page 37	Page 37	Page 38	Page 38	Page 38	Page 39	Page 39	Page 39
uvex Bamboo Twinflex® D xg	uvex D500 foam	uvex C500 M foam	uvex C500 sleeve	uvex C500	uvex C500 wet plus	uvex C500 XG	uvex C500 dry	uvex C500 foam	uvex C500 wet	uvex C300 dry	uvex C300 foam	uvex C300 wet

## Cut protection

uvex phynomic				uvex athletic			uvex unidur						
Page 40	Page 41	Page 41	Page 41	Page 42	Page 42	Page 43	Page 44	Page 44	Page 44	Page 45	Page 45	Page 43	Page 43
uvex phynomic airLite B ESD	uvex phynomic airLite C ESD	uvex phynomic C3	uvex phynomic C5	uvex athletic B XP	uvex athletic C XP	uvex athletic D5 XP	uvex unidur 6641	uvex unidur 6648	uvex unidur 6649	uvex unidur 6643	uvex unidur 6659 foam	uvex unidur sleeve C	uvex unidur sleeve C TL

## Chemical Risks

### Safety gloves with textil support - Coating: Nitrile

uvex rubiflex						uvex u-chem				uvex protector	
Page 48	Page 48	Page 48	Page 49	Page 49	Page 52	Page 50	Page 50	Page 50	Page 51	Page 54	Page 54
uvex rubiflex S	uvex rubiflex SZ	uvex rubiflex SZ XG	uvex rubiflex S XG	uvex rubiflex S	uvex rubiflex ESD	uvex u-chem 3300	uvex u-chem 3200	uvex u-chem 3100	uvex u-chem 3500	uvex protector chemical	uvex protector chemical

### Safety gloves without textil support

Page 55	Page 55	Page 53	Page 53
uvex profastrong NF33	uvex profapren CF33	uvex profabutyl B-05R	uvex profaviton BV-06

### Disposable safety gloves

uvex u-fit			
Page 57	Page 57	Page 57	Page 57
uvex u-fit strong N2000	uvex u-fit	uvex u-fit ft	uvex u-fit lite

### HexArmor gloves

Page 58-71	

# Table of contents

## Standards and product advice

### International standards for safety gloves

<b>International standards for safety gloves</b>		<b>Page</b>
DIN EN 388:2016-03	Safety gloves to protect against mechanical risks	194
DIN EN ISO 374-1:2018-10	Safety gloves to protect against dangerous chemicals and micro-organisms	195
DIN EN 16350:2014-07	Safety gloves to protect against electrostatic characteristics	197
DIN EN 60903:2003	Live working - Gloves of insulating material	197
DIN EN 61482-1-2:2015-08	Working with high voltage - Clothing that protects against the thermal hazards of an electric arc – part 1-2	197
DIN EN 407:2020-06	Safety gloves and other protective hand equipment designed to protect against thermal risks (heat and/or fire)	196
DIN EN 511:2006-07	Safety gloves to protect against the cold	196
	Suitable for use with foods (glove materials)	194

### We help you choose the right safety gloves for your needs

<b>Discover all our helpful services on our website</b>		<b>Page</b>
1	uvex Glove Navigator - The fast route to finding the right gloves for you	230
2	uvex Chemical Expert System - Chemicals database, permeation lists - uvex glove plan designer	230

**uvex – consultation and product expertise from a single source**



# Standards

EN 388:2016+A1:2018

## Standard for safety gloves to protect against mechanical risks

EN 388:2016 contains various test methods for comparing the mechanical performance of gloves. This standard focusses on the following six performance levels:

### EN 388:2016

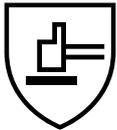

4 X 3 2 D P

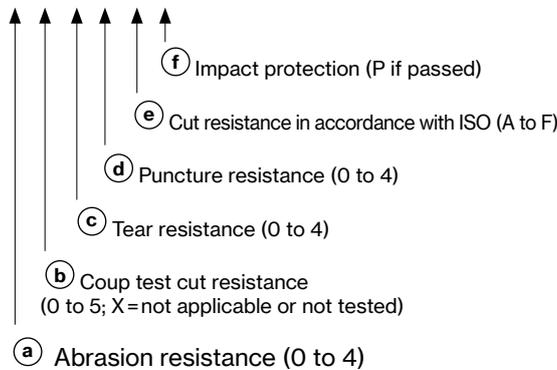

Video



**(a) Abrasion resistance**

To test the abrasion resistance of the safety glove, the material is rubbed with abrasive paper under pressure. The number of cycles required to grind a hole into the material is used as a reference value. (Highest performance class 4 = 8000 cycles)

**(b) Cut resistance by means of the coupe test**

A rotating circular knife is used to test the cut resistance of a safety glove. The knife cuts through the glove material at constant speed and constant force. The reference value is the comparison with a reference material and a resulting index. (Highest performance class 5 = index 20)

**(c) Tear resistance**

To test the tear resistance of the safety glove, the material is first cut. The reference value is the force required to tear the material. (Highest performance class 4 = 75 newtons)

**(d) Puncture resistance**

To test the puncture resistance, the material to be tested is pierced with a nail (defined dimension). The force used for this is used as a reference value.

**(e) Cut resistance according to TDM**

The application of the test method in accordance with ISO 13997 is relevant for materials that blunt the rotating circular knife during the coupe test (see above). The required force for cutting a material is measured at a defined distance (20 mm) (highest performance class F= 30 newton)

**(f) Additional impact protection**

Gloves with performance class "P" at the end offer specific impact absorption.

## Suitability grades

Safety gloves for working with food must be designed in such a way that absolutely no components can be transferred to food which may

pose a hazard to human health (migration) under normal and predictable conditions.



Area of application	Aqueous pH > 4.5	Acidic pH < 4.5	Alcoholic	Fatty	Dry, non fatty
Examples	Non-alcoholic beverages Fruit Eggs Vegetables Crustaceans	Vinegar Yeast Milk Yoghurt	Wine Spirits Liqueurs	R1 = olive oil R2 = butter, margarine R3 = fish, cheese, baked goods R4 = meat, poultry R5 = sandwiches fried food	Bread Pasta Rice Tea Spices Pulses
uvex Bamboo TwinFlex® D xg	YES	YES	YES	YES (R1 – R5)	YES
uvex phynomic airlite A ESD	YES	YES	YES	YES (R1 – R5)	YES
uvex profi ergo/ uvex contact ergo	YES	YES	YES	YES (R1 – R5)	YES
uvex phynomic C3/ uvex phynomic C5	YES	YES	YES	YES (R1 – R5)	YES
uvex rubiflex und uvex rubiflex S	YES	YES	YES	YES (R1 – R5)	YES
uvex profastrong NF 33	YES	YES	YES	YES (R2 – R5)	YES
uvex u-fit	YES	YES	YES	YES (R3 – R5)	YES
uvex phynomic foam	YES	YES	YES	YES (R5)	YES
uvex phynomic lite (w)	YES	YES	YES	YES (R1 – R5)	YES
uvex unilite thermo	YES	YES	YES	NO	YES
uvex u-fit strong N2000	YES	NO	YES	YES (R3 – R5)	YES
uvex u-fit lite	YES	NO	YES	YES (R3 – R5)	YES
uvex u-chem 3300	YES	YES	YES	YES (R2 – R5)	YES

## EN ISO 374-1:2018 Standard for safety gloves to protect against chemical risks

Chemical safety gloves must meet the requirements of European standard EN ISO 374-1. This standard has undergone fundamental changes in terms of certification.

Test chemicals: From the list of 18 test chemicals, the glove material must be tested for permeation as part of the certification process using 6, 3 or 1 chemical(s), depending on the type class.

Identifier	Test chemical	Group	Class
A	Methanol	polar*	Primary alcohol
B	Acetone		Ketone
C	Acetonitrile		Nitrile
G	Diethylamine		Amine
H	Tetrahydrofuran		Heterocyclic, ether compounds
I	Ethyl acetate		Ester
T	Formaldehyde 37%		Aldehyde
E	Carbon disulphide		Sulphur-containing organic compound
J	n-heptane	aliphatic*	
F	Toluene	aromatic*	
D	Dichloromethane	halogenated*	Chlorinated
L	Sulphuric acid 96%	Acids	Inorganic acid, oxidising
M	Nitric acid 65%		Inorganic acid, oxidising
N	Acetic acid 99%		Organic acid
S	Hydrofluoric acid 40%		Inorganic acid
K	Sodium hydroxide 40%	Bases (alkalis)	Inorganic base
O	Ammonia water 25%		Organic base
P	Hydrogen peroxide 30%	Peroxide (bleach)	Peroxide

\* Solvents (hydrocarbons (KWS))

### Labelling of safety gloves

EN ISO 374-1:2016/Type A



J K L M N O

**Permeation resistance of type A:**  
at least 30 minutes each with at least 6 test chemicals.

EN ISO 374-1:2016/Type B



J K L

**Permeation resistance of type B:**  
at least 30 minutes each with at least 3 test chemicals.

EN ISO 374-1:2016/Type C



**Permeation resistance of type C:**  
at least 10 minutes each with at least 1 test chemical.

With the uvex Chemical Expert System, uvex provides a multilingual, online platform to search for individual permeation times. In addition, experienced staff are available on-site and in the centre of expertise for safety gloves in Lüneburg to provide advice on all questions relating to safety gloves for protection against chemical risks.

Your uvex account manager will be happy to provide advice.

## DIN EN 374-5: 2016 Standard for safety gloves to protect against dangerous chemicals and micro-organisms

To protect against microorganisms such as bacteria, fungi and viruses, safety gloves must undergo and pass special penetration tests in accordance with ISO 16604:2004 (method B). Only then may they be marked with the pictogram for EN ISO 374-5.

### Labelling of safety gloves

EN ISO 374-5:2016



Virus

**Variant 1:**  
Protects against bacteria, fungi and viruses

EN ISO 374-5:2016



**Variant 2:**  
Protects against bacteria and fungi

### Labelling on the glove



- 1 Name of the manufacturer
- 2 Glove Product Name
- 3 Performance classes, mechanical
- 4 CE conformity mark
- 5 No. of Test Institute
- 6 Letters symbolise test chemicals against which the glove has a protection index of at least class 2.
- 7 Pictogram with designation of standard
- 8 Note enclosed instructions for use
- 9 Glove size
- 10 Expiration date
- 11 Manufacturer address

## Permeation

Time measured to penetration	Protection index
> 10 min	Class 1
> 30 min	Class 2
> 60 min	Class 3
> 120 min	Class 4
> 240 min	Class 5
> 480 min	Class 6

Permeation refers to molecular penetration through the safety glove material. The time required by the chemicals to permeate, determines the performance class in accordance with EN ISO 374-1.

The actual period of protection at the workplace may vary depending on real-time process factors.

# Standards

EN 407:2020 • DIN EN 511:2016

## DIN EN 407:2020 Standard for safety gloves providing protection against thermal risks – heat

The European standard **DIN EN 407** regulates the requirements for safety gloves that provide protection against thermal risks in applications involving heat. Safety gloves certified according to this standard protect the wearer against contact heat, radiant heat and small splashes of molten metal, for example.

However, this does not apply to the specific use of safety gloves in firefighting. According to DIN EN 407, heat protection gloves must have the following features:

- low flammability and low flame propagation
- low heat transmission (protection against radiant, convective and contact heat)
- high temperature resistance

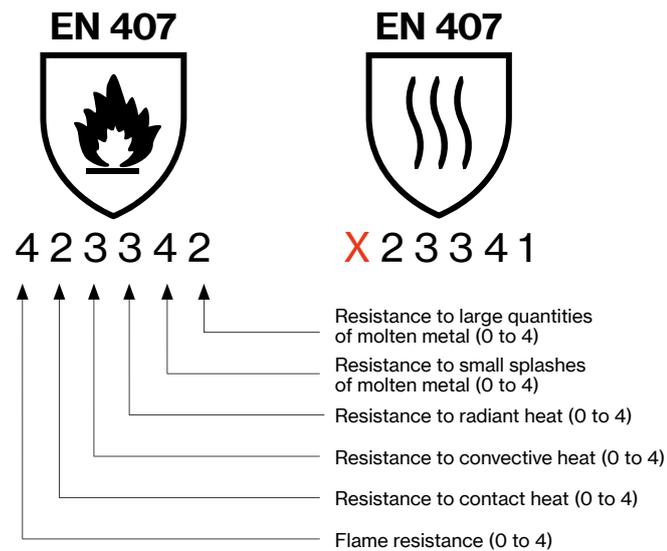

### Important changes to standards!

In the latest version of DIN EN 407: As of 2020, the first performance class is no longer named “resistance to flammability”, but is now called “limited flame spread”. If the glove has not been tested for this, a new pictogram is used (see above right). However, there are no changes to the performance classes.

The test described in DIN EN 407 assigns safety gloves a performance class in relation to each of the individual thermal hazards. It is important that the glove does not come into contact with open flames if it does not meet the criteria of performance class 3 in the limited flame spread test.

## DIN EN 511:2006 Standard for safety gloves providing protection against thermal risks – cold

Cold safety gloves must meet the requirements of the European standard **DIN EN 511**. The certified gloves below are designed to protect the wearer from penetrating ambient cold and from contact cold through direct contact.

Gloves can also be tested for water impermeability in accordance with EN ISO 15383, thus enabling them to protect the hands from wetness and moisture. This test is considered to have been passed if water does not penetrate the safety glove over a 30-minute period.

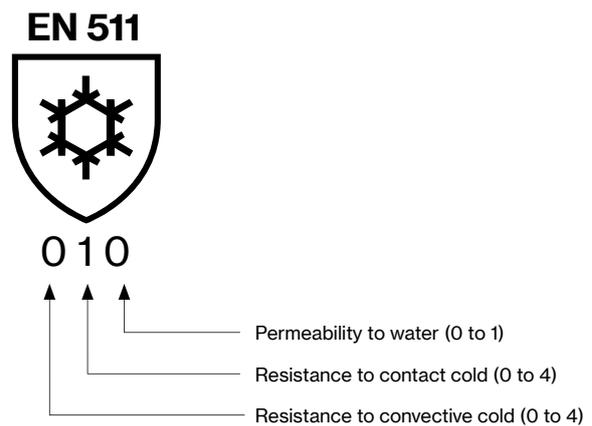

As with mechanical risk protection, the safety glove is assigned a different performance class for each individual aspect. The performance classes are indicated by a number from 0 to 4 next to the pictogram, whereby 4 is the highest performance class.



## DIN EN 16350:2014 Safety gloves – Electrostatic characteristics

The new standard

Choosing the right personal protective equipment (PPE) is particularly important in working environments that are hazardous or harbour health risks. For workplaces at risk of fire and explosive atmospheres, “EN 16350:2014 – Protective gloves – electrostatic properties” is the first European standard to prescribe the test conditions and minimum requirements for electrostatic properties of safety gloves.

- ▶ vertical resistance must be less than  $1.0 \times 10^8 \Omega$  ( $R_V < 1.0 \times 10^8 \Omega$ ).
- ▶ test atmosphere: ambient temperature of  $23 \pm 1 \text{ }^\circ\text{C}$ , relative humidity of  $25 \pm 5\%$ .

### Important notice:

**Electrostatic discharge safety gloves are only effective if the wearer is grounded with resistance of less than  $10^8 \Omega$ .**

What should users take into account?

EN 16350:2014 is the first standard to define a limit value for vertical resistance for protective gloves; this value was not included in DIN EN 1149.

Users must therefore check the suitability of the protective gloves in line with EN 16350:2014.

References to EN 1149 are no longer sufficient, as this standard only describes the testing procedure and does not specify a limit value.

More on  
this topic:



## DIN EN 60903:2003 Live working – Gloves made from insulating material

DIN EN 60903-compliant safety gloves are category iii PPE. The insulation protection class of the insulating personal protective equipment (PPE) is determined according to the nominal voltage of the plant, with both the maximum permissible nominal AC voltage (AC) and the nominal DC voltage (DC) being calculated.

### Labelling of safety gloves



Insulation protection class	Max. permissible nominal AC voltage (AC)	Max. permissible nominal direct voltage (DC)
00	500 volts	750 volts
0	1,000 volts	1,500 volts
1	7,500 volts	11,250 volts
2	17,000 volts	25,000 volts
3	26,500 volts	39,750 volts
4	36,000 volts	54,000 volts

### Additional identifier

Category	Resistant to
A	Acids
H	Oil
Z	Ozone
C	Extremely low temperatures

## DIN EN 61482-1-2:2015-08 Live working - Protective clothing against the thermal hazards of an electric arc

Part 1-2: Test methods – Method 2:

Determining the arc protection class of the material and the clothing using a directed test arc (box test)

Hands are at the greatest risk of burns from short circuit electric arcs when working on electrical equipment. Unfortunately, there is no recognised standard for safety gloves in Germany for testing the potential dangers of a short circuit electric arc. Therefore, safety gloves for protection against the thermal discharge of a short circuit electric arc are generally tested in accordance with EN 61482-1-2 and classified accordingly.

Class	Test current [kA]	Arcing time [ms]	Arc energy [kJ]	Incident energy [kJ/m <sup>2</sup> ]
1	4	500	168 +/- 17	146 +/- 28
2	7	500	320 +/- 22	427 +/- 39

# Mechanical Risks

Area of application: precision/all-round

 Precision	 All-round	 Heavy duty
Activities where a high level of sensitivity is necessary.	General, multiple activities for which robust, stable safety gloves are required.	Tough activities requiring highly robust, abrasion resistant safety gloves.
Examples: fine assembly work, working with small parts (e.g. screws), operating controls, end inspection.	Examples: servicing, transport work, light metal processing, standard assembly work, maintenance.	Examples: heavy transport work (e. g. palette transport), construction, servicing.

 dry	 <p>uvex phynomic airLite A ESD uvex phynomic lite/lite w uvex unipur range uvex rubipor range</p>	 <p>uvex phynomic foam</p>	
 light moisture / oily		 <p>uvex athletic lite ESD uvex athletic lite uvex phynomic allround uvex athletic lite dry</p>	 <p>uvex unilite thermo</p>
 wet / oily		 <p>uvex phynomic wet uvex phynomic wet plus uvex phynomic XG uvex phynomic pro 2</p>	 <p>uvex phynomic pro uvex unilite thermo plus c</p>
		 <p>uvex contact ergo uvex profi ergo uvex rubiflex NB27 uvex 7710 F</p>	 <p>uvex profi XG uvex compact uvex unilite thermo HD</p>



Working areas which do not have any moisture (water, oil, fat, cooling lubricant, etc.). Safety gloves for these conditions are extremely breathable.  
Examples: quality control, assembly work, distribution, end processing.



Working areas with some moisture. Safety gloves for these conditions are less breathable. The water/oil-repelling coating is crucial and also guarantees slip-resistance.  
Examples: oil-coated parts, changing between dry and damp working environments.



Working areas in which hands should be protected from liquids (not chemicals). Sealed safety gloves with high slip-resistance are necessary.  
Examples: removing oily/wet parts from machines, outdoor activities (weather-related humidity).

# uvex phynomic

## Perfection in 3 dimensions

### 1. Perfect fit



#### 3D ergo technology – precision all the way to the fingertips

- Ergonomic solution for every wearer: up to 8 perfectly coordinated sizes
- The advantages for the wearer:
  - the glove fits like a second skin
  - natural touch
  - maximum flexibility for fatigue-free work

### 2. Optimum functionality



#### Coatings perfectly adapted to the application at hand

- for dry areas: aqua-polymer waterproofing
- for dry and slightly damp areas: aqua-polymer foam coating
- for humid and oily areas: aqua-polymer xtra grip foam coating
- for wet and oily areas: aqua-polymer pro coating
- for applications with industrial touchscreen monitors: airLite aqua-polymer foam coating\*\*\*

### 3. Skin safe – product safe



#### Enhanced skin care and product protection

- Health protection
- no skin irritation
  - dermatologically approved\*
  - certified in accordance with OEKO-TEX® Standard 100
  - free from harmful solvents (DMF, TEA)
  - free from allergenic substances
- Product protection
- silicone-free according to imprint test
  - suitable for sensitive surfaces
  - does not leave any traces/marks
  - certified for food processes\*\*

clima zone

MADE IN GERMANY 

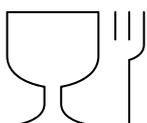

\* The uvex phynomic series was clinically tested by the proDERM® Institute for Applied Dermatological Research (Hamburg, Germany). The extremely good skin tolerability of uvex phynomic safety gloves has been dermatologically tested (proDERM® studies: 11.0356-02, 11.0482-11, 13.0202-02, 15.0188-02, 15.0219-11). Detailed information on the award criteria applied by the certification bodies OEKO-TEX® and proDERM can be found at: [uvex-safety.com/certificates](http://uvex-safety.com/certificates)

\*\* Models uvex phynomic lite/lite w, uvex phynomic foam, uvex phynomic C3 and phynomic C5

\*\*\* Models uvex phynomic airLite A ESD, uvex phynomic airLite B ESD, uvex phynomic airLite C ESD

# Mechanical Risks

Area of application: precision/all-round

## An intelligent future

More and more companies are integrating intelligent methods into their production process. The digitalisation of industrial production (Industry 4.0.) is still on its way. You will be equipped for the future with the uvex phynomic airLite A ESD thanks to its touchscreen compatibility for use on almost all screens, tablets and mobile phones.



This applies to all products marked with this symbol.

## Health protection and the latest uvex coating technology

The newly developed "airLite" aqua-polymer coating in combination with a high-quality liner (18 gauge) offers not only touchscreen compatibility but also the highest sensitivity and tactile feel for precision work when handling very small or fine components.

It has also been tested by the proDERM® institute in an elaborate user-study process and its skin compatibility has been dermatologically approved.



The uvex phynomic airLite ESD range also offers gloves with cut protection in Cut Level B and C. See page 40/41 for details.



60038



MADE IN GERMANY

## uvex phynomic airLite A ESD

- the lightest safety glove in its class
- ESD function (DIN EN 16350:2014)
- a noticeable difference in wearer comfort: combination of high sensitivity and tactile feel, lightness and breathability
- touchscreen compatibility for use on almost all screens, tablets and mobile phones
- thin and breathable "airLite" aqua-polymer coating combines the highest sensitivity and tactile feel with touchscreen compatibility
- very good grip in dry and slightly damp areas
- free from accelerators, health protection and skin compatibility dermatologically approved (proDERM®), highly suitable for allergy sufferers
- certified according to OEKO-TEX® Standard 100 (S02-0648 HOHENSTEIN HTTI)

	uvex phynomic airLite A ESD
Art. no.	60038
Design	knitted cuff
Standard	EN 388 (3 110 X), EN 16350
Material	polyamide, elastane, carbon
Coating	palm and fingertips with airLite aqua-polymer coating
Suitable for	for dry and slightly damp areas of application
Colour	black
Sizes	6 to 12
Order quantity multiples	10 PR

You can find more information at [www.uvex-safety.com/airlite](http://www.uvex-safety.com/airlite)



# Mechanical Risks

Area of application: precision/all-round



60050



60049



60070



## uvex phynomic foam

- dexterity safety glove for precision mechanical work
- very good mechanical abrasion resistance thanks to the damp-resistant aqua-polymer foam coating
- good grip in dry and slightly damp areas
- highly breathable coating
- outstanding tactile feel when assembling parts
- free from accelerators, health protection and skin compatibility dermatologically approved (proDERM®), highly suitable for allergy sufferers
- certified according to OEKO-TEX® Standard 100 (S02-0648 HOHENSTEIN HTTI)

	uvex phynomic foam
<b>Art. no.</b>	60050
<b>Design</b>	knitted cuff
<b>Standard</b>	EN 388 (3 1 2 1 X)
<b>Material</b>	polyamide, elastane
<b>Coating</b>	palm and fingertips with aqua-polymer foam coating
<b>Suitable for</b>	dry areas and slightly damp areas
<b>Colour</b>	white, grey
<b>Sizes</b>	5 to 12
<b>Order unit</b>	10 PR

## uvex phynomic allround

- light and dirt-resistant all-round safety glove for mechanical activities
- very good mechanical abrasion resistance thanks to the damp-resistant aqua-polymer foam coating
- good grip in dry and slightly damp areas
- highly breathable coating
- outstanding tactile feel when assembling parts
- free from accelerators, health protection and skin compatibility dermatologically approved (proDERM®), highly suitable for allergy sufferers
- certified according to OEKO-TEX® Standard 100 (S02-0648 HOHENSTEIN HTTI)

	uvex phynomic allround
<b>Art. no.</b>	60049
<b>Design</b>	knitted cuff
<b>Standard</b>	EN 388 (3 1 2 1 X)
<b>Material</b>	polyamide, elastane
<b>Coating</b>	palm and fingertips with aqua-polymer foam coating
<b>Suitable for</b>	dry areas and slightly damp areas
<b>Colour</b>	grey, black
<b>Sizes</b>	5 to 12
<b>Order unit</b>	10 PR

## uvex phynomic XG

- flexible and extremely durable assembly glove with the best oil grip in its class
- outstanding mechanical abrasion resistance thanks to the aqua-polymer Xtra Grip coating
- outstanding grip in oily areas
- high level of breathability with the porous foam coating
- very good tactile feel when assembling (oily) parts
- free from accelerators, health protection and skin compatibility dermatologically approved (proDERM®), highly suitable for allergy sufferers
- certified according to OEKO-TEX® Standard 100 (S02-0648 HOHENSTEIN HTTI)

	uvex phynomic XG
<b>Art. no.</b>	60070
<b>Design</b>	knitted cuff
<b>Standard</b>	EN 388 (4 1 2 1 X)
<b>Material</b>	polyamide, elastane
<b>Coating</b>	aqua-polymer xtra grip foam coating on palm and fingertips
<b>Suitable for</b>	damp and oily working conditions
<b>Colour</b>	black, black
<b>Sizes</b>	6 to 12
<b>Order unit</b>	10 PR



# Mechanical Risks

Area of application: precision/all-round

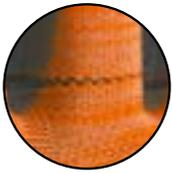

Break section



60054



MADE IN GERMANY



60060



60061



MADE IN GERMANY

## uvex phynomic x-foam HV

- unique safety glove with break sections
- reduced tear resistance in the finger area with the integration of a seamless break section, which clearly reduces the risk of severe hand injuries when using hand-held power tools
- very good mechanical abrasion resistance thanks to the damp-resistant aqua-polymer foam coating
- good grip in dry and slightly damp areas
- highly breathable coating
- outstanding tactile feel when assembling parts

- free from accelerators, health protection and skin compatibility dermatologically approved (PRO-DERM®), highly suitable for allergy sufferers
- certified according to OEKO-TEX® Standard 100 (S02-0648 HOHENSTEIN HTTI)

**NOTE:**

- only partially suitable for handling moving machine parts
- a thorough hazard analysis with the support of our uvex hand protection specialists is vital before use

## uvex phynomic wet · uvex phynomic wet plus

- safety glove with water-repellent aqua-polymer foam coating for use in outdoor areas
- outstanding mechanical abrasion resistance thanks to the durable coating
- very good grip in damp and wet areas
- high level of breathability due to the coating

- very good tactile feel when assembling parts
- free from accelerators, health protection and skin compatibility dermatologically approved (PRO-DERM®), highly suitable for allergy sufferers
- certified according to OEKO-TEX® Standard 100 (S02-0648 HOHENSTEIN HTTI)

Art. no.	uvex phynomic x-foam HV 60054
Design	knitted cuff
Standard	EN 388 (3 1 X 1 X)
Material	polyamide, elastane
Coating	palm and fingertips with aqua-polymer foam coating
Suitable for	dry areas and slightly damp areas
Colour	orange, grey
Sizes	6 to 12
Order quantity multiples	10 PR

Art. no.	uvex phynomic wet 60060	uvex phynomic wet plus 60061
Design	knitted cuff	knitted cuff
Standard	EN 388 (3 1 3 1 X)	EN 388 (3 1 3 1 X)
Material	polyamide, elastane	polyamide, elastane
Coating	palm and fingertips with aqua-polymer foam coating	palm and 3/4 of the back of the hand with aqua-polymer foam coating
Suitable for	damp and oily working conditions	damp and oily working conditions
Colour	blue, anthracite	blue, anthracite
Sizes	6 to 12	6 to 12
Order quantity multiples	10 PR	10 PR



# Mechanical Risks

Area of application: precision/all-round/heavy duty

## uvex phynomic pro: comfort made by uvex

In addition to protective function, safety gloves for assembly work must meet a variety of other demands placed on them by the wearer. These include dexterity, a comfortable internal temperature, flexibility and a slip-resistant coating, of which all ensure the gloves do not hinder work.

These requirements are met by a number of safety gloves currently available on the market. However, the workplace often involves a combination of activities, when wearers still need to have an excellent sense of touch even if there is a significant amount of dirt or moisture. If open cell coatings continue to be used in these environments, the hands become dirty, wet or oily as well as reduced product life and regular replacement rates.

This is where uvex's new product concept comes into its own.

**The coating:** the innovative aqua-polymer-pro coating features dirt and moisture-repellent properties. The gloves are coated up to and including the knuckles. It remains completely flexible and offers exceptional dry and wet grip (in both wet and oily applications).

**The liner:** uvex has already set new standards in cut protection with the patented Bamboo-TwinFlex® technology. The uvex phynomic pro represents a further ground-breaking development in the Cut 1 segment.

The liner combines bamboo with polyamide/elastane. The dirt and moisture-repellent coating requires that it is particularly important that the fibre combination is absorbent and wicks moisture away from the skin. The silky feel of this fibre also feels pleasant on the skin.

**Purity "Made in Germany":** This product in the uvex phynomic range has also been tested by the proDERM® Institute to confirm the skin compatibility and dermatological tolerance through a comprehensive process of repeated patch tests and in-use studies.



60064



60062



MADE IN GERMANY

### uvex phynomic pro 2 · uvex phynomic pro

- high dexterity and dirt- and damp-resistant safety glove
- good mechanical abrasion resistance thanks to the durable aqua-polymer Pro coating
- very good grip in damp, wet and oily areas
- High breathability and very good moisture absorption thanks to the bamboo viscose liner
- very good tactile feel when handling parts
- outstanding wearer comfort on the skin thanks to the bamboo-polyamide-elastane liner
- free from accelerators, health protection and skin compatibility dermatologically approved (proDERM®), highly suitable for allergy sufferers
- certified according to OEKO-TEX® Standard 100 (S02-0648 HOHENSTEIN HTTI)

	uvex phynomic pro 2 60064	uvex phynomic pro 60062
<b>Art. no.</b>	60064	60062
<b>Design</b>	knitted cuff	knitted cuff
<b>Standard</b>	EN 388 (2 1 2 1 X)	EN 388 (2 1 2 1 X)
<b>Material</b>	bamboo, polyamide, elastane	bamboo, polyamide, elastane
<b>Coating</b>	palm and fingertips with aqua-polymer foam coating	palm and 3/4 of the back of the hand with aqua-polymer pro coating
<b>Suitable for</b>	damp and oily working conditions	damp and oily working conditions
<b>Colour</b>	blue, anthracite	blue, anthracite
<b>Sizes</b>	6 to 12	6 to 12
<b>Order quantity multiples</b>	10 PR	10 PR



# Mechanical Risks

Area of application: precision/all-round



60040



60041



MADE IN GERMANY

## uvex phynomic lite · uvex phynomic lite w

- lightweight safety glove for fatigue-free work
- good mechanical abrasion resistance thanks to the very thin but highly durable aqua-polymer impregnation
- good grip in dry and slightly damp areas
- very high level of breathability with the porous coating, which reduces sweating
- outstanding tactile feel when handling small parts
- free from accelerators, dermatologically approved skin compatibility (proDERM®), highly suitable for allergy sufferers
- certified according to OEKO-TEX® Standard 100 (S02-0648 HOHENSTEIN HTTI)

<b>Art. no.</b>	uvex phynomic lite 60040	uvex phynomic lite w 60041
<b>Design</b>	knitted cuff	knitted cuff
<b>Standard</b>	EN 388 (2 1 2 1 X)	EN 388 (2 1 2 1 X)
<b>Material</b>	polyamide, elastane	polyamide, elastane
<b>Coating</b>	palm and fingertips with aqua-polymer impregnation	palm and fingertips with aqua-polymer impregnation
<b>Suitable for</b>	dry and slightly damp areas of application	dry and slightly damp areas of application
<b>Colour</b>	grey, grey	white, white
<b>Sizes</b>	5 to 12	5 to 12
<b>Order quantity multiples</b>	10 PR	10 PR



# Mechanical Risks

Area of application: precision/all-round



60276



60316



60028



MADE IN GERMANY

## uvex rubipor XS

- lightweight, elastic safety glove with stretch cotton material
- good grip in dry areas
- very high level of breathability with the thin layer of NBR impregnation
- very good tactile feel through the flexible stretch cotton material with elastane
- ergonomic fit

- certified according to OEKO-TEX® Standard 100 (S02-0648 HOHENSTEIN HTTI)

## uvex athletic allround

- lightweight and dirt-resistant all-round safety glove for mechanical tasks
- very good mechanical abrasion resistance thanks to the damp-resistant aqua-polymer foam coating
- very good grip in dry and slightly damp areas
- perfect fit thanks to the "slim fit" design and elastane with liner
- certified according to OEKO-TEX® Standard 100 (S02-0648 HOHENSTEIN HTTI)

Art. no.	uvex rubipor XS2001 60276	uvex rubipor XS5001B 60316
Design	knitted cuff	knitted cuff
Standard	EN 388 (1110 X)	EN 388 (1110 X)
Material	cotton interlock, elastane	cotton interlock, elastane
Coating	palm and fingertips coated with breathable	palm and fingertips coated with breathable
Suitable for	NBR special impregnation dry areas of application	NBR special impregnation dry areas of application
Colour	white, white	white, blue
Sizes	6 to 10	6 to 10
Order quantity multiples	10 PR	10 PR

Art. no.	uvex athletic allround 60028
Design	knitted cuff
Standard	EN 388 (4122 X)
Material	polyamide, elastane
Coating	palm and fingertips with NBR foam coating
Suitable for	dry and slightly damp areas
Colour	grey, anthracite
Sizes	6 to 11
Order quantity multiples	10 PR



# Mechanical Risks

Area of application: precision/all-round

**NEW**



60027



60035

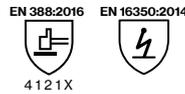

60033

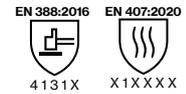

## uvex athletic lite

- lightweight and sensitive safety glove for mechanical tasks
- matt, porous and particularly abrasion-resistant microfoam coating
- very good grip in dry and slightly damp areas
- high breathability thanks to the porous coating, reducing sweating
- perfect fit thanks to the “slim fit” design and elastane in the liner
- certified according to OEKO-TEX® Standard 100 (S02-0648 HOHENSTEIN HTTI)

	uvex athletic lite
<b>Art. no.</b>	60027
<b>Design</b>	knitted cuff
<b>Standard</b>	EN 388 (4 1 3 2 X)
<b>Material</b>	polyamide, elastane
<b>Coating</b>	palm and fingertips with NBR foam coating
<b>Suitable for</b>	dry and slightly damp areas
<b>Colour</b>	blue, anthracite
<b>Sizes</b>	6 to 11
<b>Order quantity multiples</b>	10 PR

## uvex athletic lite ESD

- lightweight and sensitive safety glove for mechanical tasks, even a little thinner and with higher dexterity than the uvex athletic lite
- touchscreen ability and ESD function according to DIN EN 16350:2014
- matt, porous and particularly abrasion-resistant microfoam coating
- very good grip in dry and slightly damp areas
- high breathability thanks to the porous coating, reducing sweating
- perfect fit thanks to the “slim fit” design and elastane in the liner
- certified according to OEKO-TEX® Standard 100 (S02-0648 HOHENSTEIN HTTI)

	uvex athletic lite ESD
<b>Art. no.</b>	60035
<b>Design</b>	knitted cuff
<b>Standard</b>	EN 388 (4 1 2 1 X), DIN EN 16350:2014
<b>Material</b>	polyamide, elastane, carbon
<b>Coating</b>	palm and fingertips with NBR foam coating
<b>Suitable for</b>	dry and slightly damp areas
<b>Colour</b>	blue, anthracite
<b>Sizes</b>	6 to 11
<b>Order quantity multiples</b>	10 PR

## uvex athletic lite dry

- lightweight and sensitive safety glove for mechanical tasks
- matt, porous and particularly abrasion-resistant microfoam coating
- with nubbing, for increased durability and a good grip
- sehr gute Griffsicherheit in trockenen und very good grip in dry and slightly damp areas
- high breathability thanks to the porous coating, reducing sweating
- perfect fit thanks to the “slim fit” design and elastane in the liner
- certified according to OEKO-TEX® Standard 100 (S02-0648 HOHENSTEIN HTTI)

	uvex athletic lite dry
<b>Art. no.</b>	60033
<b>Design</b>	knitted cuff
<b>Standard</b>	EN 388 (4 1 3 1 X), EN 407 (X 1 X X X X)
<b>Material</b>	polyamide, elastane
<b>Coating</b>	palm and fingertips with NBR foam coating, dots
<b>Suitable for</b>	dry and slightly damp areas
<b>Colour</b>	blue, anthracite
<b>Sizes</b>	6 to 12
<b>Order quantity multiples</b>	10 PR



# Mechanical Risks

Area of application: precision/all-round



60573



60585



60321



## uvex unilite 6605

- lightweight knitted glove with NBR foam coating for mechanical precision work
- good mechanical abrasion resistance with the polyamide liner and coating
- good grip in dry and slightly damp areas
- breathable
- good tactile feel
- good fit
- highly flexible

## uvex unilite 7700

- flexible and durable safety glove for mechanical precision work
- good mechanical abrasion resistance with the polyamide-elastane liner and NBR polyurethane coating
- good grip in dry and slightly damp to slightly oily areas
- good tactile feel
- very good fit
- highly flexible

## uvex unipur 6634

- moisture-proof NBR safety glove for mechanical applications outdoors
- very good abrasion resistance with the polyamide liner and NBR coating
- good grip in damp areas
- good tactile feel
- good fit
- highly flexible

Art. no.	uvex unilite 6605 60573
Design	knitted cuff
Standard	EN 388 (4 1 2 2 X)
Material	polyamide
Coating	palm and fingertips coated with nitrile foam coating
Suitable for	dry and slightly damp areas
Colour	black, black
Sizes	6 to 11
Order quantity multiples	10 PR

Art. no.	uvex unilite 7700 60585
Design	knitted cuff
Standard	EN 388 (4 1 3 1 X)
Material	polyamide, elastane
Coating	palm and fingertips coated with NBR/polyurethane coating
Suitable for	dry and damp, oily working conditions
Colour	grey, black
Sizes	7 to 11
Order quantity multiples	10 PR

Art. no.	uvex unipur 6634 60321
Design	knitted cuff
Standard	EN 388 (4 1 3 1 X)
Material	polyamide
Coating	palm and fingertips coated with NBR coating
Suitable for	damp, oily or greasy areas of application
Colour	grey, black
Sizes	7 to 10
Order quantity multiples	10 PR



# Mechanical Risks

Area of application: precision/all-round



60943



60944



60248



## uvex unipur 6630 · uvex unipur 6631

- light and very sensitive PU safety glove for mechanical precision work
- good mechanical abrasion resistance
- good grip in dry and slightly damp areas
- outstanding tactile feel
- very good fit
- highly flexible

## uvex unipur 6639

- lightweight, high dexterity and dirt-resistant PU safety glove for mechanical precision work
- good mechanical abrasion resistance
- good grip in dry and slightly damp areas
- outstanding tactile feel
- very good fit
- highly flexible

	uvex unipur 6630	uvex unipur 6631
<b>Art. no.</b>	60943	60944
<b>Design</b>	knitted cuff	knitted cuff
<b>Standard</b>	EN 388 (4 1 4 1 X)	EN 388 (4 1 4 1 X)
<b>Material</b>	polyamide	polyamide
<b>Coating</b>	palm and fingertips coated with polyurethane coating	palm and fingertips coated with polyurethane coating
<b>Suitable for</b>	dry and slightly damp areas	dry and slightly damp areas
<b>Colour</b>	white, white	grey, grey
<b>Sizes</b>	6 to 11	6 to 11
<b>Order quantity multiples</b>	10 PR	10 PR

	uvex unipur 6639
<b>Art. no.</b>	60248
<b>Design</b>	knitted cuff
<b>Standard</b>	EN 388 (4 1 3 1 X)
<b>Material</b>	polyamide
<b>Coating</b>	palm and fingertips coated with polyurethane coating
<b>Suitable for</b>	dry and slightly damp areas
<b>Colour</b>	black, black
<b>Sizes</b>	6 to 11
<b>Order quantity multiples</b>	10 PR



# Mechanical Risks

Area of application: precision/all-round



60556

Variant with microdots on palm

60587

Variant without microdots on palm

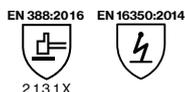
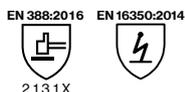

60238



60135



**MADE IN GERMANY**

## uvex unipur carbon

- sensitive and anti-static safety glove for precision work with electronic parts
- very good grip
- fulfils requirement of DIN EN 16350:2014
- very high level of breathability
- outstanding tactile feel
- Art.No. 60556: Made in Germany

## uvex unigrip

- knitted safety gloves with 13-gauge (uvex unigrip PA and uvex unigrip 6620) for precise mechanical work and 10 gauge (uvex unigrip 6624) for rougher mechanical activities
- good grip with the thin PVC dots in dry areas

	uvex unipur carbon	uvex unipur carbon FT
<b>Art. no.</b>	60556	60587
<b>Design</b>	knitted cuff	knitted cuff
<b>Standard</b>	EN 388 (2 1 3 1 X) EN 16350	EN 388 (2 1 3 1 X) EN 16350
<b>Material</b>	polyamide, carbon	polyamide, carbon
<b>Coating</b>	palm with carbon microdots, fingertips with thin elastomer coating	fingertips with thin elastomer coating
<b>Suitable for</b>	dry areas of application	dry areas of application
<b>Colour</b>	grey, black, white	grey, white
<b>Sizes</b>	6 to 10	6 to 10
<b>Order quantity multiples</b>	10 PR	10 PR

	uvex unigrip 6624	uvex unigrip 6620
<b>Art. no.</b>	60238	60135
<b>Design</b>	knitted cuff, 10-gauge	knitted cuff, 13-gauge
<b>Standard</b>	EN 388 (2 2 4 2 B)	EN 388 (2 2 4 1 B)
<b>Material</b>	polyamide, cotton	polyamide, cotton
<b>Coating</b>	palm and fingers coated with PVC dots	palm and fingers coated with PVC dots
<b>Suitable for</b>	dry areas of application	dry areas of application
<b>Colour</b>	grey, red	white, blue
<b>Sizes</b>	7 to 10	7 to 10
<b>Order quantity multiples</b>	10 PR	10 PR



# Mechanical Risks

Area of application: all-round/heavy duty



60150



60147



60148



**MADE IN GERMANY**

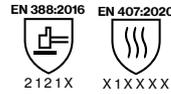

**MADE IN GERMANY**



**MADE IN GERMANY**

## uvex contact ergo

- thick, hard-wearing cotton interlock safety glove with NBR coating
- very good grip in damp, wet and oily areas
- good tactile feel
- ergonomic fit
- highly flexible
- good wearer comfort with high water vapour absorption of the cotton lining
- certified according to OEKO-TEX® Standard 100 (S02-0648 HOHENSTEIN HTTI)

## uvex profi ergo

- cotton interlock safety glove with NBR coating for universal use
- very good grip in damp, wet and oily areas
- good tactile feel
- ergonomic fit
- high flexibility
- very good wearer comfort due to the high water vapour absorption of the cotton lining
- certified according to OEKO-TEX® Standard 100 (S02-0648 HOHENSTEIN HTTI)

	uvex contact ergo ENB20C
<b>Art. no.</b>	60150
<b>Design</b>	knitted cuff
<b>Standard</b>	EN 388 (2 1 2 1 X)
<b>Material</b>	cotton interlock
<b>Coating</b>	palm and fingers with special NBR coating (nitrile rubber)
<b>Suitable for</b>	oily and greasy areas of application
<b>Colour</b>	white, orange
<b>Sizes</b>	6 to 10
<b>Order quantity multiples</b>	10 PR

	uvex profi ergo ENB20A	uvex profi ergo ENB20
<b>Art. no.</b>	60147	60148
<b>Design</b>	knitted cuff	knitted cuff
<b>Standard</b>	EN 388 (2 1 2 1 X), EN 407 (X 1 X X X X)	EN 388 (2 1 2 1 X), EN 407 (X 1 X X X X)
<b>Material</b>	cotton interlock	cotton interlock
<b>Coating</b>	palm and 3/4 of the back of the hand with special NBR coating (nitrile rubber)	palm and whole back of the hand with special NBR coating (nitrile rubber)
<b>Suitable for</b>	damp, oily or greasy areas of application	damp, oily or greasy areas of application
<b>Colour</b>	white, orange	white, orange
<b>Sizes</b>	6 to 11	6 to 10
<b>Order quantity multiples</b>	10 PR	10 PR



# Mechanical Risks

Area of application: all-round/heavy duty

Exceptional grip



60558

Exceptional grip



60208



6047900



## uvex profi ergo XG

- safety glove with uvex Xtra Grip Technology
- very good mechanical abrasion resistance thanks to the multi-layer design for increased service life
- outstanding grip in damp, wet and oily areas
- good tactile feel
- ergonomic fit
- highly flexible
- very good wearer comfort with high water vapour absorption of the cotton lining
- certified according to OEKO-TEX® Standard 100 (S02-0648 HOHENSTEIN HTTI)

## uvex glove clip

- universal fastening options due to snap hooks
- easy handling
- suitable for all gloves
- gloves are quickly fixed and released
- perfect hold due to jagged clamps
- uncomplicated attachment to work clothing

	uvex profi ergo XG20A	uvex profi ergo XG20
<b>Art. no.</b>	60558	60208
<b>Design</b>	knitted cuff	knitted cuff
<b>Standard</b>	EN 388 (3 1 2 1 X), EN 407 (X 1 X X X X X)	EN 388 (3 1 2 1 X), EN 407 (X 1 X X X X X)
<b>Material</b>	cotton interlock	cotton interlock
<b>Coating</b>	palm and 3/4 of the back of the hand with special NBR coating and Xtra Grip coating (nitrile rubber)	palm and whole back of the hand with special NBR and Xtra Grip coating (nitrile rubber)
<b>Suitable for</b>	damp, oily or greasy areas of application	damp, oily or greasy areas of application
<b>Colour</b>	white, orange, black	white, orange, black
<b>Sizes</b>	6 to 11	6 to 11
<b>Order quantity multiples</b>	10 PR	10 PR

	uvex glove clip
<b>Art. no.</b>	6047900
<b>Design</b>	glove keeper with snap hook
<b>Material</b>	Polycarbonate
<b>Coating</b>	without
<b>Suitable for</b>	easy access to gloves
<b>Colour</b>	black
<b>Order quantity multiples</b>	10 PC



# Mechanical Risks

Area of application: Heavy duty



89636



60278



60946

60945

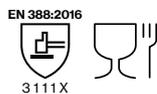

MADE IN GERMANY

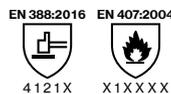

## uvex rubiflex

- fully coated cotton interlock safety glove for mechanical activities
- very good mechanical abrasion resistance with NBR coating
- good tactile feel
- ergonomic fit
- certified according to OEKO-TEX® Standard 100 (S02-0648 HOHENSTEIN HTTI)

Art. no.	uvex rubiflex NB27 89636
Design	gauntlet, approx. 27 cm
Standard	EN 388 (3 1 1 1 X)
Material	cotton interlock
Coating	fully coated with special NBR coating (nitrile rubber)
Suitable for	damp, oily or greasy areas of application
Colour	orange
Sizes	7 to 11
Order quantity multiples	10 PR

## uvex unilite 7710 F

- waterproof assembly glove with grip
- excellent grip in wet and oily areas
- extremely abrasion-resistant for heavy-duty activities
- protection against contact heat to 100°C (level 1)
- highly flexible, seamless polyester-knit liner

Art. no.	uvex-unilite 7710F 60278
Design	knitted cuff
Standard	EN 388 (4 1 2 1 X), EN 407 (X 1 X X X X)
Material	polyester (seamless)
Coating	palm and whole back of the hand with NBR (nitrile rubber) with grip finish
Suitable for	excellent grip in wet and oily areas
Colour	blue, black
Sizes	7 to 11
Order quantity multiples	10 PR

## uvex compact

- very durable NBR safety glove for rough work and manual tasks involving raw materials
- very good mechanical abrasion resistance with NBR coating

Art. no.	uvex compact NB27E 60946	uvex compact NB27H 60945
Design	canvas gauntlet	canvas gauntlet
Standard	EN 388 (4 1 2 1 B)	EN 388 (4 1 2 1 B)
Material	jersey cotton	jersey cotton
Coating	palm and 3/4 of the back of the hand with NBR coating (nitrile rubber)	palm and whole back of the hand with NBR coating (nitrile rubber)
Suitable for	damp, oily or greasy areas of application	damp, oily or greasy areas of application
Colour	white, blue	white, blue
Sizes	9 to 10	10
Order quantity multiples	10 PR	10 PR



# Mechanical Risks

Area of application: Heat risks



60213



60179



60595

Sandwich lining

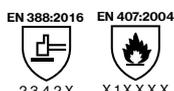

2 3 4 2 X X 1 X X X X

**MADE IN GERMANY**

Cotton cladding



2 4 4 2 D X 2 X X X X

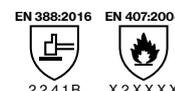

2 2 4 1 B X 2 X X X X

## uvex nk

- safety glove for thermal applications
- good mechanical abrasion resistance
- very good grip in dry, damp and oily areas through the rough surface
- very good thermal insulation in direct contact with warm to hot objects
- suitable for contact heat up to +100 °C (as per EN 407)
- certified according to OEKO-TEX® Standard 100 (S02-0648 HOHENSTEIN HTTI)

	uvex NK2722	uvex NK4022
<b>Art. no.</b>	60213	60202
<b>Design</b>	gauntlet, approx. 27 cm	gauntlet, approx. 40 cm
<b>Standard</b>	EN 388 (2 3 4 2 X), EN 407 (X 1 X X X X X)	EN 388 (2 3 4 2 X), EN 407 (X 1 X X X X X)
<b>Material</b>	cotton interlock, aramid knit	
<b>Coating</b>	fully coated with special NBR coating (nitrile rubber)	
<b>Suitable for</b>	damp, oily or greasy areas of application	
<b>Colour</b>	orange	
<b>Sizes</b>	9 to 10	9 to 10
<b>Order quantity multiples</b>	10 PR	10 PR

## uvex k-basic extra

- Kevlar® coarse-knitted glove for mechanical and thermal activities
- very good thermal insulation in direct contact with warm to hot objects
- suitable for contact heat up to +250 °C
- good cut protection
- good wearer comfort with cotton lining on the inside
- breathable

	uvex k-basic extra 6658
<b>Art. no.</b>	60179
<b>Design</b>	knitted cuff, 7-gauge
<b>Standard</b>	EN 388 (2 4 4 2 D), EN 407 (X 2 X X X X X)
<b>Material</b>	100 % Kevlar®, cotton lining (inside)
<b>Coating</b>	none
<b>Suitable for</b>	cut and heat-resistant
<b>Colour</b>	yellow
<b>Sizes</b>	8, 10, 12
<b>Order quantity multiples</b>	5 PR

## uvex profatherm

- cotton terry safety glove for thermal applications
- very good thermal insulation in direct contact with warm to hot objects
- suitable for contact heat up to +250 °C
- good wearer comfort with the cotton terry material on the inside

	uvex profatherm XB40
<b>Art. no.</b>	60595
<b>Design</b>	gauntlet, approx. 40 cm
<b>Standard</b>	EN 388 (2 2 4 1 B), EN 407 (X 2 X X X X X)
<b>Material</b>	cotton terry
<b>Coating</b>	none
<b>Suitable for</b>	insulation against heat and cold
<b>Colour</b>	white
<b>Sizes</b>	11
<b>Order quantity multiples</b>	6 PR



# Mechanical Risks

Area of application: Cold protection

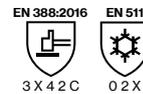
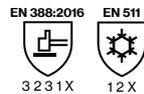
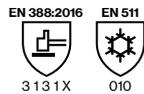
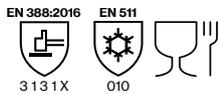

## uvex unilite thermo

- winter glove with dual-layer design
- good mechanical abrasion resistance with a polymer coating that is flexible at low temperatures
- very good thermal insulation in direct contact with cold objects
- good fit

	uvex unilite thermo	uvex unilite thermo plus	uvex unilite thermo HD
<b>Art. no.</b>	60593	60592	60942
<b>Design</b>	knitted cuff	knitted cuff	knitted cuff
<b>Standard</b>	EN 388 (3131X), EN 511 (010)	EN 388 (3131X), EN 511 (010)	EN 388 (3231X), EN 511 (12X)
<b>Material</b>	acrylic and new wool mix (lining), polyamide and elastane (outer)	acrylic and new wool mix (lining), polyamide and elastane (outer)	cotton terry material and acrylic (lining), nylon (outer)
<b>Coating</b>	palm and fingertips with cold-flexible polymer coating	palm and 3/4 of the back of the hand with cold-flexible polymer coating	palm and whole back of the hand with PVC coating, 3/4 grip coating
<b>Suitable for</b>	dry and slightly damp working conditions	dry and slightly damp working conditions	damp, oily working conditions
<b>Colour</b>	black, black	black, black	red, black
<b>Sizes</b>	7 to 11	7 to 11	8 to 11
<b>Order quantity multiples</b>	10 PR	10 PR	10 PR

## uvex unilite thermo plus cut c

- outstanding tactile feel
- high abrasion resistance
- flexible at cold temperatures
- mechanical resistance
- very high cut protection (Level C)

	uvex unilite thermo plus cut c
<b>Art. no.</b>	60591
<b>Design</b>	back of the hand partially coated, knitted cuff
<b>Standard</b>	EN 388 (3X42C), EN 511 (02 X)
<b>Material</b>	two-layer design: acrylic (inside), glass/polyamide (outside)
<b>Coating</b>	palm and fingertips with polymer coating that is flexible in the cold
<b>Suitable for</b>	dry and slightly damp working conditions
<b>Colour</b>	lime, black
<b>Sizes</b>	7 to 11
<b>Order quantity multiples</b>	10 PR



# Mechanical Risks

Area of application: Working on live parts



60840



60838

EN 60903:2003



Class 0/RC

EN 61482-1-2



Class 1

EN 388:2016



1 X 2 1 X

EN 407:2004



4 1 1 1 X X

EN 61482-1-2



Class 1

MADE IN GERMANY

## uvex power protect V1000

- protection against electrical voltages up to 1000V
- due to the anatomical shape the glove offers high dexterity
- high flexibility of the material offers high wearer comfort, even at low temperatures
- arc flash protection class 1 EN 61482-1-2 (box test)

	uvex power protect V1000
<b>Art. no.</b>	60840
<b>Design</b>	41 cm straight cuff
<b>Standard</b>	EN 60903 (Class 0/RC), EN 61482-1-2 (Class 1)
<b>Material</b>	no lining
<b>Coating</b>	natural latex, 1,6 mm
<b>Suitable for</b>	good resistance to oils, acids and ozone
<b>Colour</b>	red
<b>Sizes</b>	7 to 11
<b>Order unit</b>	PR

## uvex arc protect g1

- ergonomic fit
- good wearer comfort
- exceptional dexterity right to the fingertips
- very good protection against thermal discharge
- arc flash protection class 1 EN 61482-1-2 (box test)
- thermal protection
- certified according to OEKO-TEX® Standard 100 (S02-0648 HOHENSTEIN HTTI)

	uvex arc protect g1
<b>Art. no.</b>	60838
<b>Design</b>	27 cm cuff
<b>Standard</b>	388:2016 (1 X 2 1 X), 407 (4 1 1 1 X X), 61482-1-2 (Class 1)
<b>Material</b>	modacryl, cotton, antistatic
<b>Coating</b>	none
<b>Suitable for</b>	for dry areas of application
<b>Colour</b>	anthracite
<b>Sizes</b>	7 to 11
<b>Order quantity multiples</b>	10 PR



# Mechanical Risks

Cut protection at a glance

ISO Level 13997	 Precision	 All-round	 Heavy duty	
D	 uvex Bamboo TwinFlex D xg	 uvex athletic D5 XP	 uvex D500 foam	
				
				
C	 uvex C500	 uvex C500 dry	 uvex C300 dry	
	 uvex phynomic airLite C ESD	 uvex phynomic C5	 uvex athletic C XP	
	 uvex C300 foam	 uvex C500 foam	 uvex unidur 6659 foam	
		 uvex C300 wet	 uvex C500 wet	
			 uvex C500 wet plus	
			 uvex C500 XG	
B	 uvex phynomic airLite B ESD	 uvex phynomic C3	 uvex athletic B XP	
	 uvex unidur 6641	 uvex unidur 6648	 uvex unidur 6649	
			 uvex unidur 6643	



For safety gloves with cut protection level E and above, uvex recommends products from HexArmor®.

# Bamboo TwinFlex® technology

High-tech for greater comfort when wearing the cut protection glove



## Silky-soft feel and high moisture absorption thanks to bamboo fibre

uvex cut protection gloves based on the latest generation of patented uvex Bamboo TwinFlex® technology set new standards in protection, comfort, flexibility, dexterity and economy. The tailor-made cut-protection comfort class helps increase wearer acceptance – particularly when carrying out demanding activities – as the unique combination

of silky-soft bamboo fibre and high-tech protective fibres ensures a high level of wearer comfort and good climate characteristics while also providing effective protection. After all, a safety glove can only help to prevent accidents if the user actually wears it.

### Technology

#### Patented Bamboo TwinFlex® protection

Cut-resistant glass fibres and abrasion-resistant polyamide guarantee optimum mechanical protection. The use of steel fibres in combination with HPPE and polyamide increases the cut protection even to level D.

#### Patented Bamboo TwinFlex® comfort

Silky-soft, comfortable material on the inside of the bamboo-viscose glove ensures very high wearer comfort against the skin. The bamboo fibre not only feels incredibly good on the skin, it also has a very high and quick moisture absorption to keep your skin comfortable and dry while working.

Bamboo TwinFlex® Technology <sup>1</sup>			
Cut protection level C		Cut protection level D	
Double Face Principle			
<b>Polyamide</b> (abrasion resistance)	<b>Bamboo</b> (wearer comfort)	<b>Polyamide</b> (abrasion resistance)	<b>Bamboo</b> (wearer comfort)
<b>Glass fibres</b> (cut protection)	<b>High-grade HPPE fibres</b> (tear resistance)	<b>Steel fibres</b> (cut protection)	<b>High-grade HPPE fibres</b> (tear resistance)
e.g. uvex C500 M, uvex C500 und uvex C300		e.g. uvex Bamboo TwinFlex D xg, uvex D500 foam	

<sup>1</sup> Bamboo TwinFlex® technology is a registered brand of UVEX SAFETY Gloves GmbH & Co. KG., Germany.

# Bamboo TwinFlex® technology

High-tech for greater comfort when wearing the cut protection glove

## First-class climate control

uvex climazone – measurably enhanced comfort

- reduced sweating
- high breathability
- significantly greater moisture absorption compared to other types of fibres

Wearer comfort and an improved microclimate are the ultimate benchmarks in safety gloves. This is why the uvex climazone climate-management system in hand protection is being continuously developed together with market-leading partners and renowned testing and research institutes.

**NEW**  
uvex  
protexxion zone



**clima zone**

Noticeably superior in

- 1 Comfort
- 2 Health
- 3 Cost-effectiveness (long-lasting)
- 4 Protection, touchscreen
- 5 Quality, sustainability

**45%**

sustainable materials:

- bamboo comfort fibre
- Polyamide-Recyclate



# Bamboo TwinFlex® D xg

The latest generation of cut protection gloves – Cut Level D



Comfortable: Silky-soft bamboo fibre



Healthy: tested for skin compatibility



Long-lasting: uvex protexxion zone



Additional feature: Can be used with touchscreens



Local: Made in Germany

**XG** Xtra Grip  
**clima zone**

60090



**MADE IN GERMANY**

## uvex Bamboo TwinFlex® D xg

- the patented Bamboo TwinFlex yarn technology ensures fast absorption and high retention of moisture as well as a silky-soft feel against the skin
- uses sustainable raw materials: Bamboo fibre, recycled polyamide
- high level of sensitivity
- adaptive fit: adapts precisely to fit the shape of the hand within a few minutes of wearing
- particularly light, thin and flexible with high cut protection due to the use of the finest steel (Cut Level D)
- touchscreen capability means there is no need to remove the glove
- heat protection: Protection against contact heat up to 100°C
- long service life thanks to uvex protexxion zone and premium Xtra-Grip coating
- uvex protexxion zone with smooth material surface ensures that work processes run smoothly
- dermatologically tested, free from allergenic accelerators
- certified according to OEKO-TEX® Standard 100 (S02-0648 HOHENSTEIN HTTI)

	uvex Bamboo TwinFlex® D xg
<b>Art. no.</b>	60090
<b>Design</b>	knitted cuff
<b>Standard</b>	EN 388 (4X41D), EN 407 (X1XXXX)
<b>Material</b>	bamboo viscose, HPPE, steel, polyamide, elastane
<b>Coating</b>	aqua-polymer xtra grip foam coating
<b>Suitable for</b>	dry and damp, oily areas
<b>Colour</b>	green, black
<b>Sizes</b>	6 to 12
<b>Order quantity multiples</b>	10 PR



# Mechanical Risks

Area of application: cut protection



60604



MADE IN GERMANY



Crouch zone reinforcement



60498

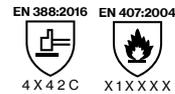

MADE IN GERMANY

## uvex D500 foam

- cut protection gloves with excellent wearer comfort, well suited for all-round activities
- high abrasion resistance thanks to the innovative Soft-Grip-Coating
- very good grip in slightly damp environments
- very high uvex cut protection with Bamboo Twin Flex® technology
- high flexibility
- very good tactile feel
- perfect fit with 3D Ergo man mold technology
- certified according to OEKO-TEX® Standard 100 (S02-0648 HOHENSTEIN HTTI)

	uvex D500 foam
<b>Art. no.</b>	60604
<b>Design</b>	knitted cuff
<b>Standard</b>	EN 388 (4 X 4 2 D)
<b>Material</b>	bamboo-rayon, Dyneema® Diamond, steel, polyamide
<b>Coating</b>	palm and fingertips with high-performance elastomer (HPE) and SoftGrip foam coating
<b>Suitable for</b>	dry areas and slightly damp areas
<b>Colour</b>	lime, anthracite
<b>Sizes</b>	7 to 11
<b>Order quantity multiples</b>	10 PR

## uvex C500 M foam

- cut protection gloves with excellent wearer comfort, well suited for all-round activities
- outstanding mechanical abrasion resistance thanks to the innovative SoftGrip coating
- very good grip in dry and slightly damp environments
- very high level of cut protection with patented Bamboo TwinFlex® technology
- suitable for contact heat up to +100 °C, in line with EN 407
- partially reinforced thumb joints
- very good tactile feel, high level of flexibility
- perfect fit with 3D Ergo man mould technology
- silicone-free according to imprint test
- certified according to OEKO-TEX® Standard 100 (S02-0648 HOHENSTEIN HTTI)

	uvex C500 M foam
<b>Art. no.</b>	60498
<b>Design</b>	crouch zone reinforcement, knitted cuff
<b>Standard</b>	EN 388 (4 X 4 2 C), EN 407 (X 1 X X X X)
<b>Material</b>	bamboo-rayon, HPPE, glass, polyamide
<b>Coating</b>	High Performance Elastomer (HPE), SoftGrip foam
<b>Suitable for</b>	for dry and slightly oily/damp areas
<b>Colour</b>	lime, black, anthracite
<b>Sizes</b>	7 to 11
<b>Order quantity multiples</b>	10 PR



# Mechanical Risks

Area of application: cut protection



60491

60497

60496

60600

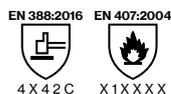

MADE IN GERMANY

## uvex C500

- cut protection glove or forearm protection (uvex C500 sleeve) with excellent wearer comfort, well suited for all-round activities
- outstanding mechanical abrasion resistance thanks to the innovative Soft Grip coating (uvex C500 wet plus and uvex C500 XG)
- very good grip in dry (all models), slightly damp/wet (uvex C500 wet plus) and oily (uvex C500 XG) environments
- very high level of cut protection with patented uvex Bamboo TwinFlex® technology

- highly flexible
- very good tactile feel
- perfect fit with 3D Ergo technology
- silicone-free according to imprint test
- certified according to OEKO-TEX® Standard 100 (S02-0648 HOHENSTEIN HTTI)

	uvex C500 sleeve	uvex C500	uvex C500 wet plus	uvex C500 XG
<b>Art. no.</b>	60491-07      60491-10	60497	60496	60600
<b>Design</b>	underarm protection with velcro fastening, 34 cm (M), 40 cm (L)	knitted cuff	knitted cuff	knitted cuff
<b>Standard</b>	EN 388 (2 X 4 X C)	EN 388 (1 X 4 X C)	EN 388 (4 X 4 2 C), EN 407 (X 1 X X X X)	EN 388 (4 X 4 2 C)
<b>Material</b>	bamboo rayon, HPPE, glass, polyamide	bamboo rayon, HPPE, glass, polyamide	bamboo rayon, HPPE, glass, polyamide	bamboo rayon, HPPE, glass, polyamide
<b>Coating</b>	none	none	palm and 3/4 of the back of the hand with high performance elastomer (HPE) coating	palm and whole back of the hand with high performance elastomer (HPE) and Xtra Grip coating
<b>Suitable for</b>	dry areas of application	dry areas of application	damp, oily or greasy areas of application	damp, wet, oily or greasy areas of application
<b>Colour</b>	lime	lime	lime, anthracite	lime, anthracite
<b>Sizes</b>	M      L	7 to 11	7 to 11	7 to 11
<b>Order quantity multiples/</b>	PC      PC	10 PR	10 PR	10 PR
<b>Order unit</b>				



# Mechanical Risks

Area of application: cut protection



60499



60494



60492

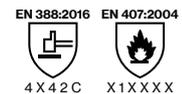
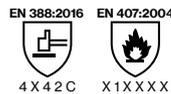

**MADE IN GERMANY**

## uvex C500

- cut protection safety gloves with outstanding wearer comfort
- outstanding mechanical abrasion resistance thanks to the innovative SoftGrip coating (uvex C500 foam and uvex C500 wet)
- very good grip in dry (all models), slightly damp (uvex C500 foam) and wet (uvex C500 wet) environments
- very high level of cut protection with patented uvex Bamboo TwinFlex® technology
- in line with EN 407, the model is suitable for contact heat up to +100°C (uvex C500 foam and C500 sleeve)
- highly flexible
- very good tactile feel
- perfect fit with 3D Ergo technology
- silicone-free according to imprint test
- certified according to OEKO-TEX® Standard 100 (S02-0648 HOHENSTEIN HTTI)

	uvex C500 dry	uvex C500 foam	uvex C500 wet
<b>Art. no.</b>	60499	60494	60492
<b>Design</b>	knitted cuff	knitted cuff	knitted cuff
<b>Standard</b>	EN 388 (X X 4 X C)	EN 388 (4 X 4 2 C), EN 407 (X 1 X X X X)	EN 388 (4 X 4 2 C), EN 407 (X 1 X X X X)
<b>Material</b>	bamboo rayon, HPPE, glass, polyamide	bamboo rayon, HPPE, glass, polyamide	bamboo rayon, HPPE, glass, polyamide
<b>Coating</b>	palm and fingers with high performance vinyl (HPV) grip dots	palm and fingertips with high performance elastomer (HPE) and Soft Grip foam coating	palm and fingertips with high performance elastomer (HPE) coating
<b>Suitable for</b>	dry areas of application	dry areas of application	damp, oily or greasy areas of application
<b>Colour</b>	lime, anthracite	lime, anthracite	lime, anthracite
<b>Sizes</b>	7 to 11	7 to 11	7 to 11
<b>Order quantity multiples</b>	10 PR	10 PR	10 PR



# Mechanical Risks

Area of application: cut protection



60549



60544



60542



MADE IN GERMANY

## uvex C300

- cut protection glove with excellent wearer comfort
- outstanding mechanical abrasion resistance thanks to the innovative SoftGrip coating (uvex C300 foam and uvex C300 wet)
- very good grip in dry (all models), slightly damp (uvex C300 foam) and wet (uvex C300 wet) environments

- good cut protection with patented uvex Bamboo TwinFlex® technology
- highly flexible
- very good tactile feel
- perfect fit with 3D Ergo technology
- silicone-free according to imprint test
- certified according to OEKO-TEX® Standard 100 (S02-0648 HOHENSTEIN HTTI)

	uvex C300 dry	uvex C300 foam	uvex C300 wet
<b>Art. no.</b>	60549	60544	60542
<b>Design</b>	knitted cuff	knitted cuff	knitted cuff
<b>Standard</b>	EN 388 (X X 4 X C)	EN 388 (3 X 4 2 C)	EN 388 (4 X 4 2 C)
<b>Material</b>	bamboo rayon, HPPE, glass, polyamide	bamboo rayon, HPPE, glass, polyamide	bamboo rayon, HPPE, glass, polyamide
<b>Coating</b>	palm and fingers with high performance vinyl (HPV) grip dots	palm and fingertips with high performance elastomer (HPE) and Soft Grip foam coating	palm and fingertips with high performance elastomer (HPE) coating
<b>Suitable for</b>	dry areas of application	dry areas of application	damp, oily or greasy areas of application
<b>Colour</b>	anthracite	anthracite	anthracite
<b>Sizes</b>	7 to 11	7 to 11	7 to 11
<b>Order quantity multiples</b>	10 PR	10 PR	10 PR



## uvex phynomic Perfection in 3 dimensions

1. Perfect fit
2. Optimal function
3. Absolute purity

uvex phynomic gloves are characterised by their ergonomic fit, which is perfectly matched to the intended use, and above all by their outstanding health protection. They are free from allergenic accelerators and harmful solvents, and their skin compatibility has been dermatologically approved through user testing by proDERM-Institut®. (see also pg. 15)

Additional functions such as touchscreen and ESD compatibility or suitability for the food industry enable use in specialist application areas



60078



MADE IN GERMANY



### uvex phynomic airLite B ESD

- the lightest and most sensitive cut protection glove in Cut Level B
- ESD function (DIN EN 16350:2014)
- noticeable difference in wearer comfort: combination of the highest sensitivity, lightness and high breathability
- touchscreen compatibility for use on almost all screens, tablets and mobile phones
- thin, breathable "airLite" aqua-polymer coating in combination with a high-quality liner (18 gauge) offers the highest sensitivity and tactile feel for precision work
- very good grip in dry and slightly damp areas
- free from glass and steel fibres
- certified according to OEKO-TEX® Standard 100 (S02-0648 HOHENSTEIN HTTI)

Art. no.	uvex phynomic airLite B ESD 60078
Design	knitted cuff
Standard	EN 388 (3 X 3 2 B), EN 16350
Material	Dyneema® Diamond Technology, polyamide, elastane, carbon
Coating	aqua-polymer coating airLite on palm and fingertips
Suitable for	dry areas and slightly damp areas
Colour	sky blue, black
Sizes	6 to 12
Order quantity multiples	10 PR



# Mechanical Risks

Area of application: cut protection



60084

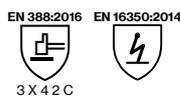

MADE IN GERMANY



60080



MADE IN GERMANY



60081

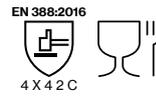

MADE IN GERMANY



## uvex phynomic airLite C ESD

- the lightest and most sensitive cut protection glove in Cut Level C
- ESD function (DIN EN 16350:2014)
- noticeably thin and sensitive in combination with high cut protection (Level C) thanks to innovative cut protection fibres: Dyneema® Diamond 2.0
- free from glass and steel fibres
- touchscreen compatibility for use on almost all screens, tablets and mobile phones
- thin, breathable "airLite" aqua-polymer coating in combination with a high-quality liner (18 gauge) offers the highest sensitivity and tactile feel for precision work
- very good grip in dry and slightly damp areas
- certified according to OEKO-TEX® Standard 100 (S02-0648 HOHENSTEIN HTTI)

## uvex phynomic C3

- sensitive cut protection safety glove for mechanical activities
- suitable for use in the food industry
- very good mechanical abrasion resistance thanks to the damp-resistant aqua-polymer foam coating
- good grip in dry and slightly damp areas
- good cut protection and high tear resistance
- highly breathable coating
- outstanding tactile feel when assembling parts
- certified according to OEKO-TEX® Standard 100 (S02-0648 HOHENSTEIN HTTI)

## uvex phynomic C5

- all-round cut protection safety glove for mechanical activities
- suitable for use in the food industry
- very good mechanical abrasion resistance thanks to the moisture-resistant aqua-polymer foam coating
- very good grip in dry and slightly damp areas
- very good cut protection (level C) and high tear resistance
- highly breathable coating
- outstanding tactile feel when assembling parts
- sustainable: with 45% bio-based HPPE (DSM Dyneema)
- certified according to OEKO-TEX® Standard 100 (S02-0648 HOHENSTEIN HTTI)



Art. no.	uvex phynomic airLite C ESD 60084
Design	knitted cuff
Standard	EN 388 (3 X 4 2 C), EN 16350
Material	Dyneema® Diamond 2.0 Technology, polyamide, elastane, carbon
Coating	palm and fingertips with aqua-polymer coating airLite
Suitable for	dry areas and slightly damp areas
Colour	blue, black
Sizes	6 to 12
Order quantity multiples	10 PR

Art. no.	uvex phynomic C3 60080
Design	knitted cuff
Standard	EN 388 (4 X 4 3 B)
Material	polyamide, elastane, HPPE, glass
Coating	aqua-polymer foam coating on palm and fingertips
Suitable for	dry areas and slightly damp areas
Colour	sky blue, grey
Sizes	6 to 12
Order quantity multiples	10 PR

Art. no.	uvex phynomic C5 60081
Design	knitted cuff
Standard	EN 388 (4 X 4 2 C)
Material	Dyneema® Diamond Technology (bio-based), polyamide, elastane
Coating	palm and fingertips with aqua-polymer foam coating
Suitable for	dry areas and slightly damp areas
Colour	blue, grey
Sizes	6 to 12
Order quantity multiples	10 PR



# Mechanical Risks

Area of application: cut protection



## uvex athletic B XP

- very high cut protection (Level B)
- good grip on dry and (slightly)
- oily/wet workpieces
- very good mechanical abrasion resistance
- reinforced thumb joints
- high flexibility, very good fit
- very good tactile feel
- suitable for industrial washing
- certified according to OEKO-TEX® Standard 100 (S02-0648 HOHENSTEIN HTTI)

Art. no.	uvex athletic B XP 60036
Design	knitted cuff
Standard	EN 388 (4 X 4 4 B)
Material	HPPE, glas, polyamide, elastane
Coating	palm and fingertips coated, micro NBR foam coating
Suitable for	dry and slightly damp/oily working conditions
Colour	grey, anthracite
Sizes	6 to 12
Order quantity multiples	10 PR

## uvex athletic C XP

- very high cut protection (Level C)
- good grip on dry and (slightly)
- oily/wet workpieces
- very good mechanical abrasion resistance
- reinforced thumb joints
- high flexibility, very good fit
- very good tactile feel
- suitable for industrial washing
- certified according to OEKO-TEX® Standard 100 (S02-0648 HOHENSTEIN HTTI)

Art. no.	uvex athletic C XP 60037
Design	knitted cuff
Standard	EN 388 (4 X 4 3 C)
Material	HPPE, glas, polyamide, elastane
Coating	palm and fingertips coated, micro NBR foam coating
Suitable for	dry and slightly damp/oily working conditions
Colour	grey, anthracite
Sizes	6 to 12
Order quantity multiples	10 PR



# Mechanical Risks

Area of application: cut protection



Crouch zone reinforcement ▶

60030



60974

60973



## uvex athletic D5 XP

- very high cut protection (Level D)
- good grip on dry and (slightly) oily/wet workpieces
- very good mechanical abrasion resistance
- reinforced thumb joints
- high flexibility, very good fit
- very good tactile feel
- suitable for industrial washing
- certified according to OEKO-TEX® Standard 100 (S02-0648 HOHENSTEIN HTTI)

Art. no.	uvex athletic D5 XP
Design	60030 knitted cuff
Standard	EN 388 (4 X 4 3 D)
Material	HPPE, steel, polyamide, elastane
Coating	palm and fingertips coated, micro NBR foam coating
Suitable for	dry and slightly damp/oily working conditions
Colour	grey, anthracite
Sizes	6 to 11
Order quantity multiples	10 PR

## uvex unidur sleeve C · uvex unidur sleeve C TL

- very high cut protection (Cut Level C)
- very thin and flexible
- high comfort
- velcro fastening for a custom fit
- 60974: thumb loop (TL) for added safety (protection against cuts on the wrist)
- certified according to OEKO-TEX® Standard 100 (S02-0648 HOHENSTEIN HTTI)

Art. no.	uvex unidur sleeve C	uvex unidur sleeve C TL
Design	60973 Lower arm protection with velcro fastening	60974 Lower arm protection with velcro fastening with thumb loop
Standard	46 cm (size M), 50 cm (size L) EN 388 (2 X 4 X C)	
Material	HPPE, glass, polyamide	
Coating	without coating	
Suitable for	for dry areas	
Colour	mottled grey	mottled grey
Sizes	M, L	M, L
Order unit	PC	PC



# Mechanical Risks

Area of application: cut protection



60210



60932



60516



## uvex unidur 6641

- PU cut protection safety glove with high-quality Special Cut Performance PE fibre
- outstanding mechanical abrasion resistance thanks to a good combination of fibres and coating
- good grip in dry and slightly damp areas
- good cut protection due to high-quality Special Cut Performance PE fibre
- very good tactile feel
- highly flexible
- outstanding comfort

## uvex unidur 6648 · uvex unidur 6649

- PU cut protection glove with HPPE fibres
- outstanding mechanical abrasion resistance
- good grip in damp and oily areas
- good cut protection with HPPE fibres
- good tactile feel
- highly flexible
- good wearer comfort

	uvex unidur 6641
<b>Art. no.</b>	60210
<b>Design</b>	knitted cuff
<b>Standard</b>	EN 388 (4 3 4 3 B)
<b>Material</b>	HPPE, elastane
<b>Coating</b>	palm and fingertips with polyurethane coating
<b>Suitable for</b>	dry areas and slightly damp areas
<b>Colour</b>	white, grey
<b>Sizes</b>	6 to 11
<b>Order quantity multiples</b>	10 PR

	uvex unidur 6648	uvex unidur 6649
<b>Art. no.</b>	60932	60516
<b>Design</b>	knitted cuff	knitted cuff
<b>Standard</b>	EN 388 (4 3 4 2 B)	
<b>Material</b>	HPPE, elastane	HPPE, polyamide, elastane
<b>Coating</b>	palm and fingertips with polyurethane coating	
<b>Suitable for</b>	dry areas and slightly damp areas	
<b>Colour</b>	white, black	mottled blue, grey
<b>Sizes</b>	6 to 11	7 to 11
<b>Order quantity multiples</b>	10 PR	10 PR



# Mechanical Risks

Area of application: cut protection



60314



60938



## uvex unidur 6643

- NBR cut protection safety glove with high-quality Special Cut Performance PE fibre
- outstanding mechanical abrasion resistance with NBR coating
- good grip in damp and oily areas
- good cut protection due to high-quality Special Cut Performance PE fibre
- good tactile feel
- highly flexible
- good wearer comfort

Art. no.	uvex unidur 6643 60314
Design	knitted cuff
Standard	EN 388 (4 3 4 4 B)
Material	HPPE, polyamide, elastane
Coating	palm and fingertips with NBR coating (nitrile rubber)
Suitable for	damp, oily or greasy areas of application
Colour	mottled grey, black
Sizes	7 to 10
Order quantity multiples	10 PR

## uvex unidur 6659 foam

- cut protection glove with NBR foam coating and HPPE/glass fibre
- outstanding mechanical abrasion resistance with NBR coating
- good grip in dry and slightly damp areas
- high level of cut protection with HPPE and glass fibre combination
- very good tactile feel
- highly flexible
- outstanding comfort

Art. no.	uvex unidur 6659 foam 60938
Design	knitted cuff
Standard	EN 388 (4 X 4 4 C)
Material	HPPE, glass, polyamide
Coating	palm and fingertips with nitrile foam coating
Suitable for	dry areas and slightly damp areas
Colour	mottled grey, black
Sizes	6 to 11
Order quantity multiples	10 PR



# uvex Chemical Expert System

Consultation and product expertise from a single source

## The uvex Glove Navigator

The fast route to finding the right gloves for you  
 The uvex Glove Navigator guides you through the entire uvex safety glove range



<https://www.uvex-safety.com/en/products/schutzhandschuhberater/>

## uvex Chemical Expert System:

Online chemicals database and glove plans  
 As a manufacturer, we offer you access to our extensive on-line chemicals database. In just a few steps, you can access information about the resistance of our safety gloves when handling chemicals.

### Register for free and get access to the following premium features:

- Full access to the test results of all listed chemicals
- Creation and management of your own permeation lists
- Use of the glove plan designer: Access the glove plans created by our experts.
- Creation and management of your own glove plans



<https://ces.uvex.de>

## uvex Chemical Expert System (online)

### Chemicals database for safety gloves

Sort by Hazardous substance ↔ Safety gloves (permeation lists)



### Gloves plan designer

Sort by Activity ↔ Safety gloves (glove plans)

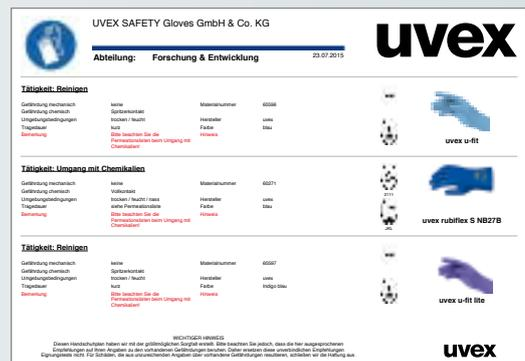



# Chemical Risks

## Selecting the right hand protection

Chemical protection gloves must be used in a wide variety of areas of application while still enabling wearers to complete tasks effectively.

This is why uvex very pays close attention to the requirements placed on the product in the possible areas of application when developing new chemical protection gloves.

The matrix shown will help you choose the most suitable material for chemical protection gloves:

Handling chemicals	Example industries	Potential contact/splash	Irregular contact	Permanent contact	Explosion-prone area
<b>aliphatic (grease, mineral oil)</b>	Cleaning agents petroleum industry Adhesives Paint production	Nitrile	Nitrile	Nitrile	uvex rubiflex ESD
<b>Polar</b>	Cleaner/universal thinner Loctite/industrial adhesive Coating industry Printing industry Raw materials in the chemical industry Intermediates in the chemical industry	Nitrile Chloroprene	Nitrile Chloroprene	Butyl	uvex profabutyl
<b>polar (alcohols)</b>	Disinfectant, raw materials in the chemical industry	Nitrile Chloroprene	Nitrile Chloroprene	Nitrile Chloroprene Butyl	uvex rubiflex ESD, uvex profabutyl
<b>aromatic, halogenated</b>	Solvents for paints, resins, oils etc. Adhesives Printing and coating industry	Nitrile	Nitrile	Viton	
<b>aqueous solutions, diluted acids/bases</b>	water treatment (sewage plant) commercial cleaning	Nitrile Chloroprene	Nitrile Chloroprene	Nitrile Chloroprene Chloroprene/nitrile	uvex rubiflex ESD
<b>concentrated acids/bases</b>	electroplating surface treatment of aluminium (anodised), steel, raw materials in the chemical industry, fertiliser production, food industry/raw materials in the polymer industry	Nitrile Chloroprene	Nitrile Chloroprene	Nitrile Chloroprene Chloroprene/nitrile Butyl	uvex profabutyl

# Chemical Risks

## Safety gloves with cotton support: NBR coating

Reinforced construction 



89646



89647



89651



**MADE IN GERMANY** 



**MADE IN GERMANY** 

### uvex rubiflex S

- NBR chemical protection glove with reinforced cotton interlock supporting material
- good mechanical abrasion resistance thanks to the NBR coating
- good resistance to many chemicals, acids, alkalis, mineral oils and solvents
- good heat insulation with reinforced supporting material
- good tactile feel
- ergonomic fit
- outstanding wearer comfort due to the high-quality cotton interlock supporting material
- highly flexible
- certified according to OEKO-TEX® Standard 100 (S02-0648 HOHENSTEIN HTTI)

uvex rubiflex S	NB27S	NB35S	NB40S
<b>Art. no.</b>	89646	98891	98902
<b>Design</b>	gauntlet, approx. 27 cm	gauntlet, approx. 35 cm	gauntlet, approx. 40 cm
<b>Standard</b>	EN 388 (2 1 2 1 X), EN ISO 374-1:2016 / Type A (J K N O P T), EN 407 (X 1 X X X X)		
<b>Material</b>	cotton interlock, reinforced	cotton interlock, reinforced	cotton interlock, reinforced
<b>Coating</b>	fully coated with NBR special coating (nitrile rubber), approx. 0.50 mm	fully coated with NBR special coating (nitrile rubber), approx. 0.50 mm	fully coated with NBR special coating (nitrile rubber), approx. 0.50 mm
<b>Suitable for</b>	very good resistance to grease, mineral oils and many chemicals		
<b>Colour</b>	green	green	green
<b>Sizes</b>	8 to 11	8 to 11	8 to 11
<b>Order quantity multiples</b>	10 PR	10 PR	10 PR

### uvex rubiflex S (long version)

- long NBR chemical protection glove with reinforced cotton interlock supporting material
- additional elastic collar at gauntlet end (NB60SZ/NB80SZ)
- good mechanical abrasion resistance thanks to the NBR coating
- good resistance to many chemicals, acids, alkalis, mineral oils and solvents
- good tactile feel
- ergonomic fit
- outstanding wearer comfort due to the high-quality cotton interlock supporting material
- highly flexible
- certified according to OEKO-TEX® Standard 100 (S02-0648 HOHENSTEIN HTTI)

uvex rubiflex S	NB60S	NB80S	NB60SZ	NB80SZ
<b>Art. no.</b>	89647	60190	89651	60191
<b>Design</b>	gauntlet, approx. 60 cm	gauntlet, approx. 80 cm	elastic collar at gauntlet end, approx. 60 cm	elastic collar at gauntlet end, approx. 80 cm
<b>Standard</b>	EN 388 (2 1 2 1 X), EN ISO 374-1:2016/Type B (J K O P T), EN 407 (X 1 X X X X)			
<b>Material</b>	cotton interlock, reinforced	cotton interlock, reinforced	cotton interlock, reinforced	cotton interlock, reinforced
<b>Coating</b>	fully coated with special NBR coating (nitrile rubber), approx. 0.50 mm			
<b>Suitable for</b>	very good resistance to grease, mineral oils and many chemicals			
<b>Colour</b>	green	green	green	green
<b>Sizes</b>	9 to 11	9 to 11	9 to 11	9 to 11
<b>Order quantity multiples</b>	10 PR	10 PR	10 PR	10 PR

# Chemical Risks

## Safety gloves with cotton support: NBR coating



Exceptional grip

60557



Lightweight and flexible

60224

LABS-conformity VDMA  
24364-A1/A2-L/W

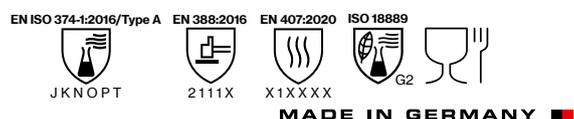

### uvex rubiflex S XG

- lightweight, stockinette NBR chemical protection glove with optimal grip properties
- very good mechanical abrasion resistance and good lifecycle thanks to multi-layered structure
- outstanding grip in wet and oily areas thanks to uvex Xtra Grip technology
- good resistance to grease, mineral oils and many chemicals
- very good tactile feel
- ergonomic fit
- outstanding wearer comfort due to the high-quality cotton interlock supporting material
- extremely high flexibility
- certified according to OEKO-TEX® Standard 100 (S02-0648 HOHENSTEIN HTTI)

	uvex rubiflex S XG27B	uvex rubiflex S XG35B
<b>Art. no.</b>	60560	60557
<b>Design</b>	gauntlet, approx. 27 cm	gauntlet, approx. 35 cm
<b>Standard</b>	EN 388 (3 1 2 1 X)	EN 388 (3 1 2 1 X), ISO 18889 (G2)
	EN ISO 374-1:2016/Type A (J K N O P T), EN 407 (X 1 X X X X)	
<b>Material</b>	cotton interlock	cotton interlock
<b>Coating</b>	fully coated with special NBR coating (nitrile rubber) and XG Grip coating, approx. 0.40 mm	fully coated with special NBR coating (nitrile rubber) and XG Grip coating, approx. 0.40 mm
<b>Suitable for</b>	very good resistance to grease, mineral oils and many chemicals	very good resistance to grease, mineral oils and many chemicals
<b>Colour</b>	blue, black	blue, black
<b>Sizes</b>	7 to 11	7 to 11
<b>Order quantity multiples</b>	10 PR	10 PR

### uvex rubiflex S

- very lightweight, stockinette NBR chemical protection glove suited to handling a variety of chemicals
- good mechanical abrasion resistance thanks to the NBR coating
- good grip in damp and wet areas
- good resistance to grease, mineral oils and many chemicals
- outstanding tactile feel
- ergonomic fit
- outstanding wearer comfort due to the high-quality cotton interlock supporting material
- extremely high flexibility
- certified according to OEKO-TEX® Standard 100 (S02-0648 HOHENSTEIN HTTI)

	uvex rubiflex S NB27B	uvex rubiflex S NB35B
<b>Art. no.</b>	60271	60224
<b>Design</b>	gauntlet, approx. 27 cm	gauntlet, approx. 35 cm
<b>Standard</b>	EN 388 (2 1 1 1 X)	EN 388 (2 1 1 1 X), ISO 18889 (G2)
	EN ISO 374-1:2016/Type A (J K N O P T), EN 407 (X 1 X X X X)	
<b>Material</b>	cotton interlock	cotton interlock
<b>Coating</b>	fully coated with special NBR coating (nitrile rubber), approx. 0.40 mm	fully coated with special NBR coating (nitrile rubber), approx. 0.40 mm
<b>Suitable for</b>	good resistance to grease, mineral oils and many chemicals	good resistance to grease, mineral oils and many chemicals
<b>Colour</b>	blue	blue
<b>Sizes</b>	7 to 11	6 to 11
<b>Order quantity multiples</b>	10 PR	10 PR



# Chemical Risks

Safety gloves with bamboo-fiber/nylon support: NBR coating



60971



60972



60968

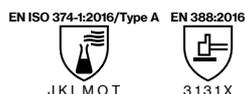

## uvex u-chem 3300

- outstanding wearer comfort
- comfortable bamboo-fiber inside
- absorption function of the natural fiber
- extremely high dexterity
- outstanding tactile feel good resistance to many chemicals

## uvex u-chem 3200

- best grip in oily conditions
- flexibility and grip
- good mechanical properties
- excellent fit

## uvex u-chem 3100

- the perfect combination of chemical protection and grip
- very good mechanical protection
- comfortable fit due to seamless cotton liner
- good resistance to many chemicals
- very good grip in wet and oily conditions
- highly flexible

	uvex u-chem 3300
<b>Art. no.</b>	60971
<b>Design</b>	cuff, fully coated, approx. 32 cm
<b>Standard</b>	EN 388 (2 1 2 1 X), EN ISO 374-1:2016 / Type A (J K L O P T)
<b>Material</b>	Bamboo-rayon/Nylon (seamless)
<b>Coating</b>	NBR (nitrile butadiene rubber), approx. 0.21 mm
<b>Suitable for</b>	good resistance to grease, mineral oils and many chemicals
<b>Colour</b>	blue
<b>Sizes</b>	7 to 11
<b>Order quantity multiples</b>	10 PR

	uvex u-chem 3200
<b>Art. no.</b>	60972
<b>Design</b>	cuff, fully coated, approx. 35 cm
<b>Standard</b>	EN 388 (3 1 3 1 X), EN ISO 374-1:2016 / Type A (J K L M O T)
<b>Material</b>	nylon weave (seamless)
<b>Coating</b>	NBR (nitrile butadiene rubber), approx. 0.50 mm
<b>Suitable for</b>	good resistance to grease, mineral oils and many chemicals
<b>Colour</b>	petrol, black
<b>Sizes</b>	7 to 11
<b>Order quantity multiples</b>	10 PR

	uvex u-chem 3100
<b>Art. no.</b>	60968
<b>Design</b>	cuff, fully coated, approx. 30 cm
<b>Standard</b>	EN 388 (4 1 2 1 X), EN ISO 374-1:2016 / Type A (A J K L M O)
<b>Material</b>	cotton (seamless)
<b>Coating</b>	NBR (nitrile butadiene rubber), approx. 0.50 mm
<b>Suitable for</b>	good resistance to grease, mineral oils and many chemicals
<b>Colour</b>	black
<b>Sizes</b>	8 to 11
<b>Order quantity multiples</b>	10 PR

# Chemical Risks

Safety gloves with cotton interlock lining material: CR/NBR coating



LABS-conformityVDMA  
24364-A1/A2-L/W

60188



## uvex u-chem 3500

- sensitive NBR broadband chemical protection glove (protection against 11 of 18 test chemicals). Material combination of nitrile and chloroprene protects against alcohols, aliphatic hydrocarbons, and concentrates acids and bases with a permeation time of  $\geq 120$  minutes.
- protection against contact heat 100 ° C (Level 1)
- very good fit, very high wearing comfort thanks to seamless cotton liner

	uvex u-chem 3500
<b>Art. no.</b>	60188
<b>Design</b>	cuff, fully coated, approx. 32cm
<b>Standard</b>	EN ISO 374-1:2016 / Typ A (A C J K L M N O P S T), EN ISO 374-5:2016 VIRUS, EN 388 ( 3 1 2 1 X ), EN 407 ( X 1 X X X X )
<b>Material</b>	cotton (seamless)
<b>Coating</b>	fully coated with Chloroprene and NBR (nitrile butadiene rubber), approx. 0.40 mm
<b>Suitable for</b>	good resistance to acetone, cleaning agents, adhesives, solvents
<b>Colour</b>	orange
<b>Sizes</b>	7 to 11
<b>Order quantity multiples</b>	10 PR

# Chemical Risks

Safety gloves with cotton support: conductive NBR coating

## The ideal solution for areas with explosive atmospheres

The introduction of the new standard EN 16350:2014 (Protective gloves – electrostatic properties) is the first standard to prescribe the electrostatic properties and testing procedure of safety gloves for work environments with risk of explosive atmospheres and fire.

- The testing conditions and minimum requirements in accordance with EN 16350:2014 are as follows:
- The contact resistance must be less than  $1.0 \times 10^8 \Omega$  ( $R_V < 1.0 \times 10^8 \Omega$ ).
- Contact resistance  $R_V$  was tested in accordance with EN 1149-2:1997.
- Test atmosphere: ambient temperature  $23^\circ\text{C} \pm 1^\circ\text{C}$ , relative air humidity  $25\% \pm 5\%$ .

uvex rubiflex ESD fulfils the requirements of the new norm EN 16350:2014.



### Functional combination of liner and coating

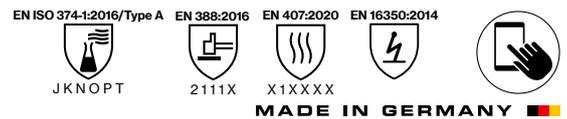
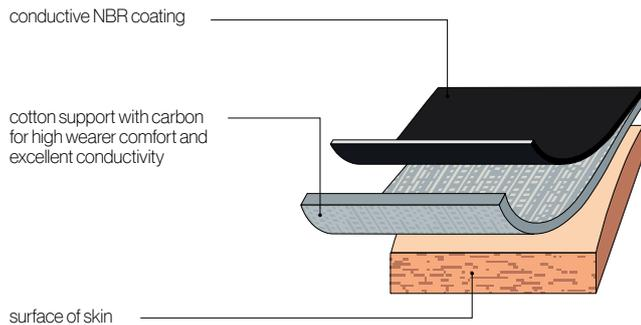

### uvex rubiflex ESD

- lightweight, stockinette and anti-static NBR chemical protection glove for applications in areas with explosion risks
- good mechanical abrasion resistance thanks to the NBR coating
- good grip in damp and wet areas
- good resistance to grease, mineral oils and many chemicals
- outstanding tactile feel
- ergonomic fit
- outstanding wearer comfort due to the high-quality cotton interlock/carbon supporting material
- extremely high flexibility
- certified according to OEKO-TEX® Standard 100 (S02-0648 HOHENSTEIN HTTI)

uvex rubiflex ESD	NB27A	NB35A
<b>Art. no.</b>	60880	60954
<b>Design</b>	gauntlet, approx. 27 cm	gauntlet, approx. 35 cm
<b>Standard</b>	EN 388 (2 111 X), EN ISO 374-1:2016 / Type A (J K N O P T), EN 16350, EN 407 (X 1 X X X X)	
<b>Material</b>	cotton interlock/carbon	cotton interlock/carbon
<b>Coating</b>	fully coated with special conductive NBR coating (nitrile rubber), approx. 0.40 mm	
<b>Suitable for</b>	good resistance to grease, mineral oils and many chemicals	
<b>Colour</b>	black	black
<b>Sizes</b>	6 to 11	6 to 11
<b>Order quantity multiples</b>	10 PR	10 PR

# Chemical Risks

## Unsupported safety gloves



60949



60957

EN ISO 374-1:2016/Type A EN 388:2016 EN 16350:2014



ABIKLNOT



2010X



MADE IN GERMANY 

EN ISO 374-1:2016/Type A EN 388:2016



AFKLMN



2120A

MADE IN GERMANY 

### uvex profabutyl

- chemical protection glove without stockinette made from butyl rubber
- good grip in damp and wet areas
- good resistance to polar bonds such as esters, ketones, aldehydes, amines and saturated saline solutions, plus acids and alkalis
- good fit
- highly flexible
- satisfies the requirements of DIN EN 16350:2014

Art. no.	uvex profabutyl B-05R 60949
Design	gauntlet, rolled edge, approx. 35 cm
Standard	EN 388 (2 0 1 0 X), EN 374 (A B I K L N O T), EN 16350
Material	without stockinette
Coating	seamlessly coated with bromobutyl (approx. 0.50 mm)
Suitable for	good resistance to polar bonds acids and alkalis
Colour	black
Sizes	7 to 11
Order unit	PR

### uvex profaviton

- chemical protection gloves made from butyl rubber with Viton® outer layer
- good grip in damp and wet areas
- good resistance to aliphatic and aromatic hydrocarbons (e.g. hexane, benzene, toluene, xylene and others), halogenated hydrocarbons (e.g. trichloroethylene, perchloroethylene, dichloromethane and others) organic and inorganic acids (diluted to concentrated), as well as saturated saline solutions
- good fit
- highly flexible

Art. no.	uvex profaviton BV-06 60957
Design	gauntlet, rolled edge, approx. 35 cm
Standard	EN 388 (2 1 2 0 A), EN ISO 374-1:2016/Type A (A F K L M N)
Material	without stockinette
Coating	seamlessly coated with bromobutyl (approx. 0.40 mm) and Viton® outer layer (approx. 0.20 mm)
Suitable for	good resistance to aliphatic and aromatic hydrocarbons, halogenated hydrocarbons
Colour	black
Sizes	8 to 11
Order unit	PR

# Chemical Risks

Area of application: cut protection



60535

60536

EN ISO 374-1:2016/Type A EN 388:2016



**MADE IN GERMANY**

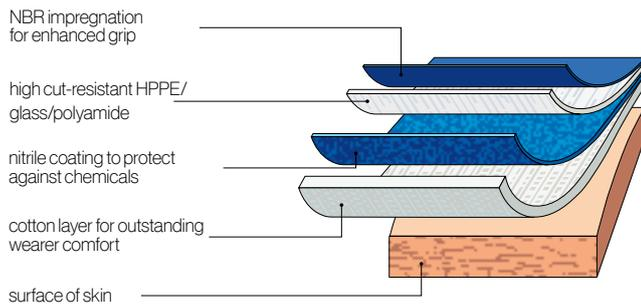

## uvex protector chemical

- very robust safety glove with multi-layer technology combining impermeability and optimal cut protection
- very high level of cut protection with the multi-layer design of the supporting material made from cotton, HPPE and glass
- good grip in damp, wet and oily areas
- uvex protector chemical also offers protection against chemicals
- good wearer comfort
- certified according to OEKO-TEX® Standard 100 (S02-0648 HOHENSTEIN HTTI)

	uvex protector chemical NK2725B	uvex protector chemical NK4025B
<b>Art. no.</b>	60535	60536
<b>Design</b>	gauntlet, approx. 27 cm	gauntlet, approx. 40 cm
<b>Standard</b>	EN 388 (4 X 4 4 C), EN ISO 374-1:2016/ Type A (J K N O P T)	EN 388 (4 X 4 4 C), EN ISO 374-1:2016/ Type A (J K N O P T)
<b>Material</b>	sandwich liner: cotton interlock, HPPE, glass, PA	
<b>Coating</b>	fully coated with special NBR coating (nitrile rubber)	
<b>Suitable for</b>	good resistance to oil, grease and many chemicals	
<b>Colour</b>	blue	blue
<b>Sizes</b>	9 to 10	9 to 10
<b>Order quantity multiples</b>	10 PR	10 PR

# Chemical Risks

## Unsupported safety gloves



60122



60119

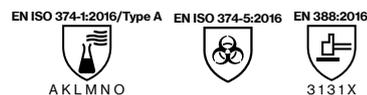

### uvex profastrong

- sensitive NBR chemical protection glove with flocked cotton
- outstanding mechanical abrasion resistance
- good grip in damp and wet areas thanks to the Grip structure in the palm
- good resistance to many oils, grease, acids and alkalis
- good tactile feel
- good fit
- highly flexible

### uvex profapren

- flexible chloroprene chemical protection glove with flocked cotton
- good grip in damp and wet areas thanks to the Grip structure in the palm
- good resistance to many chemicals and solvents
- good tactile feel
- very good fit
- highly flexible

Art. no.	uvex profastrong NF33 60122
Design	gauntlet, palm with grip structure, approx. 33 cm
Standard	EN 388 (4 1 0 1 X), EN ISO 374-1:2016/Type A (A J K L O T), EN ISO 374-5:2016 VIRUS
Material	flocked cotton
Coating	fully coated with NBR (nitrile rubber), approx. 0.38 mm
Suitable for	good resistance to oils, grease, acids and solvents
Colour	green
Sizes	7 to 11
Order quantity multiples	12 PR

Art. no.	uvex profapren CF33 60119
Design	gauntlet, roughened palm, approx. 33 cm
Standard	EN 388 (3 1 3 1 X), EN ISO 374-1:2016/Type A (A K L M N O), EN ISO 374-5:2016
Material	flocked cotton
Coating	fully coated with polychloroprene (latex inner), approx. 0.71 mm
Suitable for	good resistance to many chemicals
Colour	dark blue
Sizes	7 to 10
Order quantity multiples	10 PR



# Chemical Risks

## Disposable safety gloves

The uvex u-fit product range, provides high-quality disposable safety gloves, which guarantee a high level of safety and functionality.

uvex u-fit gloves ensures reliable wearer protection throughout industry, including the chemical, medical, food and light industry sectors enabling comfortable and precise work.

uvex disposable safety gloves are available in four different materials to cater for a wide range of application areas:

- uvex u-fit lite
- uvex u-fit
- uvex u-fit ft
- uvex u-fit strong N2000

	uvex u-fit lite	uvex u-fit	uvex u-fit ft	uvex u-fit strong N2000
Material	accelerator-free NBR (nitrile rubber)	NBR (nitrile rubber)	NBR (nitrile rubber)	NBR (nitrile rubber)
	wall thickness 0.06mm	wall thickness 0.10mm	wall thickness 0.10mm	wall thickness 0.20 mm
Certification	EN ISO 374	EN ISO 374	EN ISO 374	EN ISO 374
	EN 455	EN 455	EN 455	EN 455
	handling foodstuffs	handling foodstuffs	handling foodstuffs	handling foodstuffs
	compliance with MDR (EU) 2017/745	-	compliance with MDR (EU) 2017/745	-
Characteristics	high level of sensitivity	good mechanical abrasion resistance	good mechanical abrasion resistance	very good abrasion resistance
	hypo-allergenic	good chemical resistance	good chemical resistance	increased chemical resistance
Handling	reinforced rolled edge – easy to put on	reinforced rolled edge – easy to put on	reinforced rolled edge – easy to put on	reinforced rolled edge – easy to put on



Please contact us if you require a copy of our complete resistance list.

Detailed information can also be found in the uvex Chemical Expert System online at <https://ces.uvex.de>

Area of application	uvex u-fit lite	uvex u-fit	uvex u-fit ft	uvex u-fit strong N2000
Intended for medical examinations and to prevent infections between users and patients	++	-	++	-
Precision assembly work, dry/oily	++	+	+	-
Assembly work, dry/oily	+	+	+	++
Product protection	++	++	++	+
Gentle cleaning	+	+	+	++
Inspection	++	++	++	+
Food handling	+	+	+	+
Chemicals	short-term work, in acc. with resistance list	short-term work, in acc. with resistance list	short-term work, in acc. with resistance list	in acc. with resistance list
Paint shop	as splash protection	as splash protection	as splash protection	full contact in acc. with resistance list

# Chemical Risks

## Disposable safety gloves

Accelerator-free



60597

### uvex u-fit lite

- nitrile examination and safety gloves single use (0.06 mm)
- non-sterile, can be used on both sides, powder-free
- free from natural latex
- free from allergenic accelerators.
- good grip with the roughened fingertips
- LABS-conformity in accordance with VDMA 24364 A2-L

EN ISO 374-1:2016 / Type B EN ISO 374-5:2016



**MD**

	uvex u-fit lite
<b>Art. no.</b>	60597
<b>Design</b>	roughened fingertips, approx. 24 cm
<b>Standard</b>	EN ISO 374-1:2016/ Type B (K P T), EN 374-5:2016 VIRUS
<b>Material</b>	without stockinette
<b>Coating</b>	NBR (nitrile rubber), approx. 0.06 mm
<b>Suitable for</b>	highly resistant to grease and oil, good resistance to chemicals, for medical examinations and to prevent infections between users and patients
<b>Colour</b>	indigo blue
<b>Sizes</b>	S to XL
<b>Order unit</b>	BOX
<b>Content</b>	box of 100 PC



60596

### uvex u-fit

- nitrile single-use safety gloves (0.10 mm)
- non-sterile, can be used on both sides, powder-free
- free from natural latex
- good grip with the roughened surface
- LABS-conformity in accordance with VDMA 24364 A2-L

EN ISO 374-1:2016 / Type B EN ISO 374-5:2016



	uvex u-fit
<b>Art. no.</b>	60596
<b>Design</b>	roughened surface, approx. 24 cm
<b>Standard</b>	EN ISO 374-1:2016/ Type B (K P T), EN 374-5:2016 VIRUS
<b>Material</b>	without stockinette
<b>Coating</b>	NBR (nitrile rubber), approx. 0.10 mm
<b>Suitable for</b>	highly resistant to grease and oil, good resistance to chemicals
<b>Colour</b>	blue
<b>Sizes</b>	S to XL
<b>Order unit</b>	BOX
<b>Content</b>	box of 100 PC



60166

### uvex u-fit ft

- nitrile single-use examination and safety gloves (0.10 mm)
- non-sterile, can be used on both sides, powder-free
- free from natural latex
- good grip with the roughened fingertips
- LABS-conformity in accordance with VDMA 24364 A1/A2/A3 L/W

EN ISO 374-1:2016 / Type B EN ISO 374-5:2016



**MD**

	uvex u-fit ft
<b>Art. no.</b>	60166
<b>Design</b>	roughened fingertips, approx. 24 cm
<b>Standard</b>	EN ISO 374-1:2016/ Type A (J K P T), EN 374-5:2016 VIRUS
<b>Material</b>	without stockinette
<b>Coating</b>	NBR (nitrile rubber), approx. 0.10 mm
<b>Suitable for</b>	highly resistant to grease and oil, good resistance to chemicals, for medical examinations and to prevent infections between users and patients
<b>Colour</b>	blue
<b>Sizes</b>	XS to XL
<b>Order unit</b>	BOX
<b>Content</b>	box of 100 PC



60962

### uvex u-fit strong N2000

- nitrile single-use safety gloves (0.20 mm)
- non-sterile, can be used on both sides, powder-free
- free from natural latex
- good grip with the roughened fingertips
- LABS-conformity in accordance with VDMA 24364 A2-L/W

EN ISO 374-1:2016 / Type A EN ISO 374-5:2016



	uvex u-fit strong N2000
<b>Art. no.</b>	60962
<b>Design</b>	textured surface of fingertips, approx. 28 cm
<b>Standard</b>	EN ISO 374-1:2016/ Type A (J K L O P S T), EN 374-5:2016 VIRUS
<b>Material</b>	no lining
<b>Coating</b>	NBR (nitrile butadiene rubber), approx. 0.20 mm
<b>Suitable for</b>	highly resistant to grease and oil, increased resistance to chemicals
<b>Colour</b>	blue
<b>Sizes</b>	S to XXL
<b>Order unit</b>	BOX
<b>Content</b>	box of 50 PC

## Safety Gloves

### Needlestick

### Cut protection

								
Page 62	Page 62	Page 62	Page 63	Page 63	Page 63	Page 64	Page 64	Page 64
HexArmor PointGuard® Ultra 9032	HexArmor SharpsMaster II® 9014	HexArmor Arm Guard AG8TW	HexArmor PointGuard® Ultra 4043U	HexArmor PointGuard® Ultra 4045	HexArmor Hercules® NSR 3041	HexArmor Helix® 2082	HexArmor Helix® 2065	HexArmor Helix® 2076

### Cut protection

### Cut protection

								
Page 65	Page 65	Page 65	Page 66	Page 66	Page 66	Page 67	Page 67	Page 67
HexArmor Helix® 3033	HexArmor Helix® 2062	HexArmor Chrome SLT® 4062	HexArmor Chrome Series® 4023M	HexArmor ThornArmor 3092	HexArmor Arm Guard AG10009S	HexArmor 9000 Series 9013	HexArmor Chrome SLT 4070	HexArmor Thin Lizzie™ Thermal 2099

### Impact

### Impact

								
Page 68	Page 68	Page 68	Page 69	Page 69	Page 69	Page 70	Page 70	Page 70
HexArmor Helix® 1095	HexArmor Rig Lizard® 7101	HexArmor Thin Lizzie™ Fluid 7102	HexArmor Helix® 3000	HexArmor Helix® 3003	HexArmor Helix® 3007	HexArmor Thin Lizzie™ 2090X	HexArmor Thin Lizzie™ 2095X	HexArmor Rig Lizard® 2038

		
Page 71	Page 71	Page 71
HexArmor Rig Lizard® 2021X	HexArmor Rig Lizard® 2039	HexArmor Chrome 4026

### A Cut Above

HexArmor® is an exclusive licensee of SuperFabric® brand material in the industrial PPE market. HexArmor® products with SuperFabric® brand material have a secret weapon against cut hazards that no other glove can boast. SuperFabric® technology is designed to prevent lacerations and slashes from reaching the skin. Performance is enhanced through the configuration of tiny guard plates.

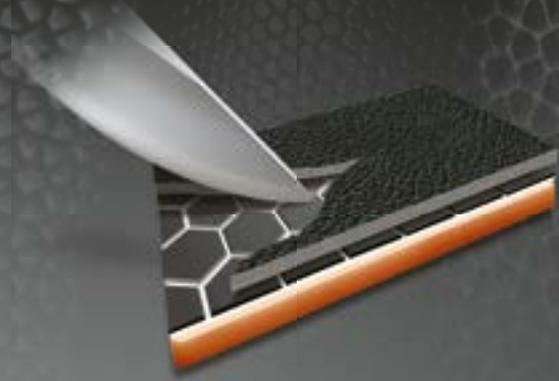

### Impact Resistance

Impacts come in all forms, shapes, and magnitudes for workers. Whether caused by falling tools, equipment or pinches, impact injuries have one thing in common: unpredictability. Individuals must always be prepared and protected from impact and pinch points, and the patented IR-X® Impact Exoskeleton™ from HexArmor® has proven to reduce the number and effects of injuries.



### Needlestick Resistance

Needles are sharp, beveled cutting instruments designed to pierce the skin. HexArmor® needle resistant products work by layering SuperFabric® brand materials over each other. SuperFabric® brand material guardplates block and deflect needle hazards or trap and arrest them in the small gaps found between guardplates. Multiple aligned layers of fabric provide extra resistance against needle hazards.

HexArmor® products are tested in real world applications and are proven to reduce needlesstick injuries. Using the correct test will ensure you have the right glove to protect your employees. As always, we recommend proper field testing to validate the appropriate level of protection necessary for your application.



Two brands with one global mission:  
**protecting people**  
**HexArmor® + uvex**

uvex and HexArmor® – two brands with one global mission: protecting people. We now offer a select range of safety gloves from HexArmor's portfolio to all uvex customers in the Eastern Hemisphere (Europe, Africa, Middle East and Russia). View the HexArmor® safety gloves range at [www.uvex-safety.com/en/hexarmor](http://www.uvex-safety.com/en/hexarmor)



Detailed information can be found at <https://www.uvex-safety.com/en/hexarmor>



## Cut resistance: Comparison between EN 388-2016 and ANSI/ISEA 105-2016

When comparing the cut resistance of two or more fabrics, it is important to make sure that for all materials:

- The same test method was used
- The same type of cut tester was used

Unless these points are met, you cannot accurately compare the results.

**Cut resistance levels:** The use of the TDM-100 test method is required by both ANSI/ISEA 105 and by EN 388 (for high-cut materials). However, the ANSI/ISEA standard reports results in grams on an A1-A9 scale (200-6000 grams/2-60 Newtons). While the A1-A9 scale is comparable to the EN 388 A-F levels which reports up to 30 Newtons (200-3000 grams/2-30 Newtons), ANSI/ISEA extends their scale by three levels to 6000 grams/60 Newtons to report high cut materials more accurately.

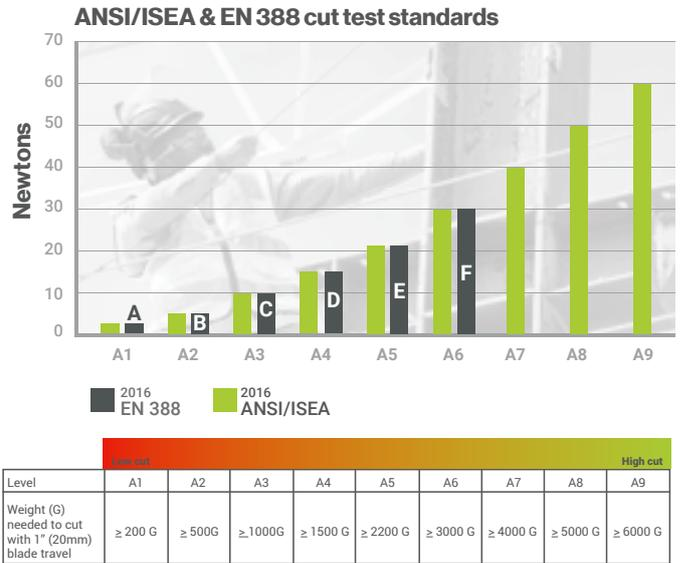

## Puncture & Needle Testing Explained

### The ANSI/ISEA 105 Test

In February of 2016, the ANSI/ISEA 105 standard was updated and published to include two puncture standards: Puncture Resistance (other than hypodermic needle) and Hypodermic Needlestick Puncture. Prior to 2015, there was only one puncture test, which did not specify the type of puncture hazard the standard was created for, leaving it open for interpretation. Having both an industrial puncture standard and a hypodermic needle puncture standard allows safety managers to differentiate between what protection they need most, based on more relevant testing and classification.



### EN 388: Industrial Puncture Resistance (Non-Hypodermic Needlestick Puncture)

The EN 388 probe is the approved puncture test for ANSI/ISEA 105 and measures the amount of force needed for a blunt probe to pierce through the sample material (taken from palm).

- The blunt probe moves at a 90° angle at a speed of 100mm/minute
- Results are reported in Newtons and are given a 1-5 classification rating, with 1 being low resistance and 5 being high resistance
- The test is done 4 times for every palm sample
- The lowest score is reported



### ASTM F2878: Hypodermic Needlestick Puncture Resistance

The ASTM F2878 is the approved puncture test for ANSI/ISEA 105 and measures the amount of force needed for a 25-gauge hypodermic needle to pierce through the sample material.

- The puncture probe (25-gauge needle) travels at a 90° angle into specimen at a vector of 500 millimeters per minute.
- Results are reported in Newtons and are giving a 1-5 classification rating, with 1 being low resistance and 5 being high resistance
- The test is done 12 times for every palm sample
- The average of the 12 results is reported

## Impact protection

Back-of-hand bones and soft tissues are extremely vulnerable to impact-related hand injuries among a wide range of job sites. This U.S.-based impact performance standard will help safety professionals make better-informed decisions about glove selection – ultimately keeping more people safe on the job.

### Impact protection: ANSI/ISEA 138

The ISEA 138 standard establishes the minimum performance, classification, and labeling requirements for gloves that are designed to protect the knuckles and fingers from impacts based on three performance levels.

**How the test works:** To score gloves into their appropriate level, impact protection testing under ISEA 138 requires consistent, regulated tests on each kind of glove on two areas for impact performance: knuckles and fingers/thumb. On both gloves, knuckles are tested four times and fingers/thumb are tested five times.

To start, one pair of gloves is required per test. The gloves are cut in half and the back-of-hand (where the impact protection is located) is placed on an anvil. A striker with a force of 5 Joules is dropped on the required back-of-hand locations, and the amount of force transferred through the glove back-of-hand is recorded with a force gauge that is connected below the anvil and measured in kiloNewtons (kN).

**Scoring:** The average of eight knuckle tests are compared to the average of the ten finger tests. The highest average of the two is the impact testing score.

- **Performance Level 1** – Results in an average peak transmitted force of less than or equal to 9 kN.
  - 55% of force absorbed
- **Performance Level 2** – Results in an average peak transmitted force of less than 6.5 kN.
  - 67.5% of force absorbed
- **Performance Level 3** – Results in an average peak transmitted force of less than 4 kN.
  - 80% of force absorbed

The chart showcases the ISEA 138 performance levels, with “Performance Level 3” being the highest. Any impact-resistant PPE that scores higher than a 9 kN force transfer will not qualify for a ranking and will fail. With no impact material, the machine registers around 20kN, so in order to pass the test, the impact material must register less than 9kN, reducing the force or energy transferred by 55%. The anvil will drop roughly around 5 ½ pounds from 8 inches.

### Impact protection: EN 388

The European industrial glove market includes impact testing performance ratings in EN 388, which tests the impact on just the knuckles, and the tests are given a basic score of pass or fail. To pass the test, the transmitted force needs to be less than or equal to 7 kN with no single results greater than 9 kN.

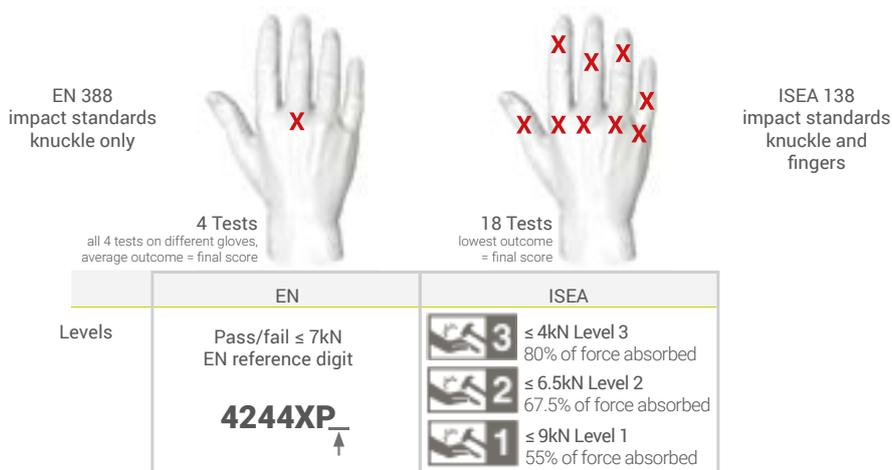

## Needlestick Series



60638



60982



60981



4 X 4 3 F

	3 Layers SuperFabric® Protection	ANSI/ISEA CUT	GRAM SCORE	ANSI/ISEA PUNCTURE
		<b>A9</b>	<b>7167</b>	<b>4</b>
		NEEDLESTICK	NEWTONS	
		<b>LEVEL 5</b>	<b>11.143</b>	



4 X 4 4 F

	3 Layers SuperFabric® Protection	ANSI/ISEA CUT	GRAM SCORE	ANSI/ISEA PUNCTURE
		<b>A9</b>	<b>7167</b>	<b>5</b>
		NEEDLESTICK	NEWTONS	
		<b>LEVEL 5</b>	<b>10.279</b>	



4 X 1 1 F

	2 Layers SuperFabric® Protection	ANSI/ISEA CUT	GRAM SCORE	ANSI/ISEA PUNCTURE
		<b>A8</b>	<b>5254</b>	<b>2</b>
		NEEDLESTICK	NEWTONS	
		<b>LEVEL 2</b>	<b>5.5125</b>	

### 9032

Article No. 60638

#### PointGuard® Ultra

- SuperFabric® brand material provides industry-leading needlestick resistance (in noted enhanced areas)
- Single-glove needle solution with incredible dexterity and comfort
- Sandy nitrile three-quarter knuckle coating

### 9014

Article No. 60981

#### SharpsMaster II®

- SuperFabric® brand material provides industry-leading needlestick resistance (in noted enhanced areas)
- Cotton blend shell provides exceptional dexterity and feel
- Wrinkle rubber latex palm coating

### AG8TW

Article No. 60982

#### Arm Guard

- SuperFabric® brand material provides industry-leading needlestick resistance
- Won't fall down like knit sleeves
- Spandex wrist insert with thumb hole and snap fasteners

	PointGuard® Ultra 9032
Article No.	60638
Standard	EN 388: 2016 (4 X 4 3 F)
Colour	yellow/blue
Sizes	7/S through 11/XXL
Order quantity multiples	1 PR

	SharpsMaster II® 9014
Article No.	60981
Standard	EN 388: 2016 (4 X 4 4 F)
Colour	white/orange
Sizes	6/XS through 10/XL
Order quantity multiples	1 PR

	AG8TW Arm Guard
Article No.	60982
Standard	EN 388: 2016 (4 X 1 1 F)
Colour	black
Sizes	7/S through 12/3XL
Order quantity multiples	1 PC

## Needlestick Series



60672



60983



60005

EN 388:2016  
4 X 4 2 F

3 Layers SuperFabric® Protection	ANSI/ISEA CUT	GRAM SCORE	ANSI/ISEA PUNCTURE
2 Layers SuperFabric® Protection	<b>A9</b>	<b>6679</b>	<b>3</b>
1 Layer SuperFabric® Protection Zone	NEEDESTICK	NEWTONS	
	<b>LEVEL 5</b>	<b>11.546</b>	
	3 Layers SuperFabric®	3 Layers SuperFabric®	
	<b>LEVEL 3</b>	<b>6.9</b>	
	2 Layers SuperFabric®	2 Layers SuperFabric®	

EN 388:2016  
4 X 2 2 F

2 Layers SuperFabric® Protection	ANSI/ISEA CUT	GRAM SCORE	ANSI/ISEA PUNCTURE
1 Layer SuperFabric® Protection Zone	<b>A7</b>	<b>4321</b>	<b>3</b>
	NEEDESTICK	NEWTONS	
	<b>LEVEL 2</b>	<b>5.284</b>	
	SuperFabric®	SuperFabric®	
	<b>LEVEL 3</b>	<b>6.9</b>	
	2 Layers SuperFabric®	2 Layers SuperFabric®	

EN 388:2016  
4 X 1 2 F

3 Layers SuperFabric® Protection	ANSI/ISEA CUT	GRAM SCORE	ANSI/ISEA PUNCTURE
2 Layers SuperFabric® Protection	<b>A9</b>	<b>8668</b>	<b>3</b>
	NEEDESTICK	NEWTONS	
	<b>LEVEL 5</b>	<b>11.59</b>	

### 4043U

Article No. 60672

#### PointGuard® Ultra

- SuperFabric® brand material provides industry-leading needlestick resistance (in noted enhanced areas)
- Back-of-hand knuckle padding for incidental bumps/impact
- Synthetic leather palm
- Neoprene cuff with Velcro® closure

	PointGuard® Ultra 4043U
Article No.	60672
Standard	EN 388: 2016 (4 X 4 2 F)
Colour	black
Sizes	7/S through 11/XXL
Order quantity multiples	1 PR

### 4045

Article No. 60005

#### PointGuard® Ultra

- SuperFabric® brand material provides industry-leading needlestick resistance (in noted enhanced areas)
- Back-of-hand knuckle padding for incidental bumps/impact
- Silicone palm pattern for enhanced grip
- Neoprene cuff with Velcro® closure

	PointGuard® Ultra 4045
Article No.	60005
Standard	EN 388: 2016 (4 X 2 2 F)
Colour	black
Sizes	6/XS through 12/3XL
Order quantity multiples	1 PR

### 3041

Article No. 60983

#### Hercules® NSR

- SuperFabric® brand material provides industry-leading needlestick resistance (in noted enhanced areas)
- Full coverage design and pre-curved shape for maximum comfort and protection
- Silicone dot palm grip

	Hercules® NSR 3041
Article No.	60983
Standard	EN 388: 2016 (4 X 1 2 F)
Colour	black
Sizes	7/S through 11/XXL
Order quantity multiples	1 PR

## Cut protection Series

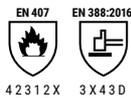

4 2 3 1 2 X 3 X 4 3 D



4 X 4 2 D



4 X 4 4 F

Aramid Blend Shell	ANSI/ISEA CUT	GRAM SCORE	ANSI/ISEA PUNCTURE
	<b>A3</b>	<b>1147</b>	<b>4</b>

HPPE Blend Shell	ANSI/ISEA CUT	GRAM SCORE	ANSI/ISEA PUNCTURE
	<b>A3</b>	<b>1274</b>	<b>3</b>

HPPE Blend Shell	ANSI/ISEA CUT	GRAM SCORE	ANSI/ISEA PUNCTURE
	<b>A6</b>	<b>3276</b>	<b>5</b>

### 2082

Article No. 60614

#### Helix®

- 13-gauge flame-resistant aramid and wool blend shell\*
- Flexible FR-compliant neoprene/nitrile blend palm coating

\*Hazard risk category HRC 1 arc flash protection (ATPV 7.7 cal/cm<sup>2</sup>, as per ASTM F2675/F2675M-13, determining arc flash rating of hand-protective devices)

### 2065

Article No. 60659

#### Helix®

- 13-gauge HPPE and fiberglass shell
- Flexible sandy nitrile palm coating
- Full flat nitrile coating offers 360° water resistance

### 2076

Article No. 60660

#### Helix®

- 13-gauge HPPE, steel, and fiberglass blend shell
- Flexible polyurethane palm coating
- Reinforced thumb crotch patch

Helix® 2082	
Article No.	60614
Standard	EN 388: 2016 (3 X 4 3 D), EN 407 (4 2 3 1 2 X)
Colour	green mottled/black
Sizes	7/S through 11/XXL
Order quantity multiples	1 PR

Helix® 2065	
Article No.	60659
Standard	EN 388: 2016 (4 X 4 2 D)
Colour	blue/black
Sizes	6/XS through 12/3XL
Order quantity multiples	1 PR

Helix® 2076	
Article No.	60660
Standard	EN 388: 2016 (4 X 4 4 F)
Colour	blue mottled/black
Sizes	5/XXS through 13/4XL
Order quantity multiples	1 PR

## Cut protection Series



60661



60655



60668

**NEW**

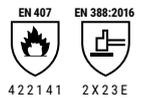

**HPPE Blend Shell**

ANSI/ISEA CUT	GRAM SCORE	ANSI/ISEA PUNCTURE
<b>A6</b>	<b>3825</b>	<b>4</b>

**Coretex™ Shell**

ANSI/ISEA CUT	GRAM SCORE	ANSI/ISEA PUNCTURE
<b>A9</b>	<b>6437</b>	<b>5</b>

**Aramid Liner**

ANSI/ISEA CUT	GRAM SCORE	ANSI/ISEA PUNCTURE
<b>A5</b>	<b>2509</b>	<b>4</b>

### 3033

Article No. 60668

#### Helix®

- Engineered knit to specifically prevent glove particles from contacting food (outer layer tested to FDA 21 CFR 177.1630 for food safe contact)
- Seamless construction for enhanced comfort and breathability
- Can be used in direct contact with food or as an underglove with appropriate top-glove solution

	Helix® 3033
<b>Article No.</b>	60668
<b>Standard</b>	EN 388: 2016 (3 X 4 1 E)
<b>Colour</b>	mottled blue
<b>Sizes</b>	6/XS through 11/2XL
<b>Order quantity multiples</b>	1 PR

### 2062

Article No. 60661

#### Helix®

- Coretex™ (13G HPPE, steel, and fiberglass blend) shell for industry-leading 360° cut resistance
- Flexible sandy nitrile palm coating
- Hi-vis color on back-of-hand

	Helix® 2062
<b>Article No.</b>	60661
<b>Standard</b>	EN 388: 2016 (4 X 4 4 F)
<b>Colour</b>	yellow/black
<b>Sizes</b>	6/XS through 12/3XL
<b>Order quantity multiples</b>	1 PR

### 4062

Article No. 60655

#### Chrome SLT®

- Arc Flash Level 4 Rating: Lab tested in accordance with HRC ATPV at 46 Cal/cm<sup>2</sup>
- Goatskin leather palm provides a traditional style of comfort and grip
- Stitched with Aramid thread
- Full aramid liner for 360° cut protection
- Extended safety cuff for easy on and off

	Chrome SLT® 4062
<b>Article No.</b>	60655
<b>Standard</b>	EN 388: 2016 (2 X 2 3 E), EN 407 (4 2 2 1 4 1)
<b>Colour</b>	beige
<b>Sizes</b>	6/XS through 12/3XL
<b>Order quantity multiples</b>	1 PR

## Cut protection Series



SuperFabric® Protection Zone	ANSI/ISEA CUT	GRAM SCORE	ANSI/ISEA PUNCTURE
	<b>A8</b>	<b>5374</b>	<b>2</b>

3 Layers SuperFabric® Protection	ANSI/ISEA CUT	GRAM SCORE	ANSI/ISEA PUNCTURE
	<b>A3</b>	<b>1274</b>	<b>3</b>
	NEEDLESTICK	NEWTONS	
	<b>LEVEL 5</b>	<b>11.94</b>	

SuperFabric® Protection Zone	ANSI/ISEA CUT	GRAM SCORE	ANSI/ISEA PUNCTURE
	<b>A7</b>	<b>4425</b>	<b>3</b>
	ANSI/ISEA ABRASION	ANSI/ISEA CONTACT HEAT	
	<b>6</b>	<b>2</b>	

### 4023M

Article No. 60673

#### Chrome

- SuperFabric® brand material provides 360° industry-leading cut resistance (interior layer)
- Durable TP-X® palm
- Elastic cuff with Velcro® closure

### 3092

Article No. 60010

#### ThornArmor 3092

- Three layers of SuperFabric®\*\* brand material in the palm and partial index finger wrap provides industry-leading cut resistance (interior layer)
- Breathable HexVent® panel on the back-of-hand helps keep you cool
- Airprene cuff with Velcro® closure for a secure fit
- Durable TP-X® palm provides superior grip and abrasion resistance

### AG10009S

Article No. 60985

#### Arm Guard AG10009S

- The SuperFabric® brand material provides industry-leading cut resistance
- Industrial puncture protection in exposed areas to help protect against injuries caused by cables, metal, wood and glass
- Elastane insert on wrist with thumb hole

	Chrome 4023M
Article No.	60673
Standard	EN 388: 2016 (4 X 4 1 F)
Colour	grey/green
Sizes	7/S through 12/3XL
Order quantity multiples	1 PR

	HexArmor ThornArmor 3092
Article No.	60010
Standard	EN 388: 2016 (4 X 3 3 F)
Colour	brown/black
Sizes	5/XXS through 11/2XL
Order quantity multiples	1 PR

	Arm Guard AG10009S
Article No.	60985
Standard	EN 388: 2016 (4 X 4 2 F)
Colour	black/neon-yellow
Sizes	6/XS through 12/3XL
Order quantity multiples	1 PC

## Cut protection Series/Impact Series

NEW



60609

NEW



60984



4 X 4 3 F

SuperFabric®  
Protection Zone



ANSI/ISEA CUT	GRAM SCORE	ANSI/ISEA PUNCTURE
A8	5022	4



4 X 4 1 F P

Impact Protection  
HPPE Blend Shell



ANSI/ISEA CUT	GRAM SCORE	ANSI/ISEA PUNCTURE
A6	3685	2



ANSI/ISEA 138  
1



60646

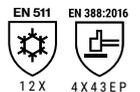

1 2 X 4 X 4 3 E P

Impact Protection  
Acrylic Blend Shell



ANSI/ISEA CUT	GRAM SCORE
A6	3132



ANSI/ISEA 138  
1

### 9013

Article No. 60984

#### 9000 Series 9013

- SuperFabric® brand materials provide industry-leading cut resistance (interior layer)
- HPPE and fiberglass blend shell
- Abrasion-resistant sandy nitrile palm coating

### 4070

Article No. 60609

#### Chrome SLT 4070

- HPPE blend liner provides 360° industry-leading cut resistance (interior layer)
- Back-of-hand impact guards provide ANSI/ISEA 138 Level 1 protection on knuckles and fingers
- Synthetic leather palm with abrasion-resistant PVC dots
- Hi-vis color on back-of-hand
- Elastic cuff with Velcro® closure for a secure fit, Pull tab

### 2099

Article No. 60646

#### Thin Lizzie™ Thermal

- Back-of-hand IR-X® Impact Exoskeleton™ with high-flex design provides ANSI/ISEA 138 Level 2 protection on knuckles and Level 1 protection on fingers
- 13-gauge acrylic and fiberglass blend shell offers 360° cut resistance
- Sandy nitrile full coating provides superior grip
- Full double-dipped coating offers liquid resistance
- Interior fleece lining for warmth

9000 Series 9013	
Article No.	60984
Standard	EN 388: 2016 (4 X 4 3 F)
Colour	mottled grey/black
Sizes	7/S through 11/2XL
Order quantity multiples	1 PR

Chrome SLT 4070	
Article No.	60609
Standard	EN 388: 2016 (4 X 4 1 F P)
Colour	orange/grey
Sizes	6/XS through 12/3XL
Order quantity multiples	1 PR

Thin Lizzie™ Thermal 2099	
Article No.	60646
Standard	EN 388: 2016 (4 X 4 3 E P), EN 511 (1 2 X)
Colour	yellow/black/red
Sizes	6/XS through 11/XXL
Order quantity multiples	1 PR

## Impact Series



60642



60652

NEW



60651

EN 388:2016  
4 1 2 1 X P

Impact Protection	ANSI/ISEA CUT	GRAM SCORE	ANSI/ISEA PUNCTURE
Nylon Blend Shell	A1	255	2
	ANSI/ISEA 138		1

EN 388:2016  
4 1 2 1 X P

Impact Protection	ANSI/ISEA CUT	GRAM SCORE	ANSI/ISEA PUNCTURE
HPPE Blend Shell	A1	257	2
	ANSI/ISEA 138		1

EN 388:2016  
4 X 4 2 C P

Impact Protection	ANSI/ISEA CUT	GRAM SCORE	ANSI/ISEA PUNCTURE
HPPE Blend Shell	A4	1274	3
	ANSI/ISEA 138		1

### 1095

Article No. 60642

#### Helix®

- High-performance 15-gauge nylon blend shell
- Flexible sandy nitrile palm coating
- Back-of-hand IR-X® Impact Exoskeleton™ with high-flex design provides ANSI/ISEA 138 Level 1 protection on knuckles and fingers

### 7101

Article No. 60651

#### Rig Lizard 7101

- Back-of-hand IR-X® Impact Exoskeleton™ with high-flex design provides ANSI/ISEA 138 Level 2 protection on knuckles and Level 1 protection on fingers
- Sandy nitrile full coating provides superior grip and abrasion resistance
- Full double dip for fluid/water resistance

### 7102

Article No. 60652

#### Thin Lizzie™ Fluid

- Back-of-hand IR-X® Impact Exoskeleton™ with high-flex design provides ANSI/ISEA 138 Level 2 protection on knuckles and Level 1 protection on fingers
- 13-gauge HPPE and fiberglass blend shell
- Sandy nitrile full coating
- Full double-dipped coating offers liquid resistance

	Helix® 1095
Article No.	60642
Standard	EN 388: 2016 (4 1 2 1 X P)
Colour	grey/black/yellow
Sizes	6/XS through 12/3XL
Order quantity multiples	1 PR

	Rig Lizard 7101
Article No.	60651
Standard	EN 388: 2016 (4 1 2 1 X P)
Colour	yellow/blue
Sizes	6/XS through 12/3XL
Order quantity multiples	1 PR

	Thin Lizzie™ Fluid 7102
Article No.	60652
Standard	EN 388: 2016 (4 X 4 2 C P)
Colour	blue/yellow
Sizes	6/XS through 12/3XL
Order quantity multiples	1 PR

## Impact Series



60665



60666



60662

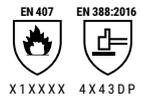
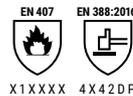

### 3000

Article No. 60662

#### Helix®

- 13-gauge HPPE and fiberglass shell
- Flexible sandy nitrile palm coating
- Back-of-hand IR-X® Impact Exoskeleton™ with high-flex design
- Reinforced thumb crotch patch

### 3003

Article No. 60665

#### Helix®

- 13-gauge HPPE and steel shell
- Flexible sandy nitrile palm coating
- Back-of-hand IR-X® Impact Exoskeleton™ with high-flex design
- Reinforced thumb crotch patch
- Elastic cuff with Velcro® closure

### 3007

Article No. 60666

#### Helix®

- IR-X® Impact Exoskeleton™ with high-flex de
- velcro closure for a good fitting
- High-performance polyethylene and glass fiber
- exceptional dexterity and feel
- Reinforced thumb crotch patch
- Sandy nitrile palm coating

	Helix® 3000
<b>Article No.</b>	60662
<b>Standard</b>	EN 388: 2016 (4 X 4 2 D P)
<b>Colour</b>	yellow/black
<b>Sizes</b>	6/XS through 12/3XL
<b>Order quantity multiples</b>	1 PR

	Helix® 3003
<b>Article No.</b>	60665
<b>Standard</b>	EN 388: 2016 (4X42 D P), EN 407 (X1 XXXX)
<b>Colour</b>	black/black
<b>Sizes</b>	7/S through 11/XXL
<b>Order quantity multiples</b>	1 PR

	Helix® 3007
<b>Article No.</b>	60666
<b>Standard</b>	EN 388: 2016 (4X43 D P), EN 407 (X1 XXXX)
<b>Colour</b>	red/yellow/black/grey
<b>Sizes</b>	6/XS through 12/3XL
<b>Order quantity multiples</b>	1 PR

## Impact Series

NEW



60648



60681



60650

EN 388:2016  
4 X 4 4 E P

Impact Protection	ANSI/ISEA CUT	GRAM SCORE	ANSI/ISEA PUNCTURE
HPPE Blend Shell	A4	2053	5
	ANSI/ISEA 138		
	1		

EN 388:2016  
4 X 4 4 F P

Impact Protection	ANSI/ISEA CUT	GRAM SCORE	ANSI/ISEA PUNCTURE
HPPE Blend Shell	A6	3276	5
	ANSI/ISEA 138		
	2		

EN 407  
X2 XXXX

EN 388:2016  
4 X 4 3 B P

Impact Protection	ANSI/ISEA CUT	GRAM SCORE	ANSI/ISEA PUNCTURE
TP-X® Technology	A2	791	4
	ANSI/ISEA 138		
	2		

### 2090X

Article No. 60648

#### Thin Lizzie™

- Back-of-hand IR-X® Impact Exoskeleton™ with high-flex design provides ANSI/ISEA 138 Level 2 protection on knuckles and Level 1 protection on fingers
- 13-gauge HPPE and glass fiber blend shell provides exceptional dexterity and feel
- Sandy nitrile palm coating
- Reinforced thumb crotch patch
- Protected by U.S. Patent No. D703,389

	Thin Lizzie™ 2090X
Article No.	60648
Standard	EN 388: 2016 (4 X 4 4 E P)
Colour	grey/yellow
Sizes	5/XXS through 12/3XL
Order quantity multiples	1 PR

### 2095

Article No. 60650

#### Thin Lizzie™

- Back-of-hand IR-X® Impact Exoskeleton™ with high-flex design provides ANSI/ISEA 138 Level 2 protection on knuckles and Level 1 protection on fingers
- 13-gauge HPPE, steel, and fiberglass blend shell
- Polyurethane palm coating
- Reinforced thumb crotch patch

	Thin Lizzie™ 2095
Article No.	60650
Standard	EN 388: 2016 (4 X 4 4 F P)
Colour	blue/black/yellow
Sizes	5/XXS through 12/3XL
Order quantity multiples	1 PR

### 2038

Article No. 60681

#### Rig Lizard 2038

- Back-of-hand sewn-on IR-X® Impact Exoskeleton™ with high-flex design provides ANSI/ISEA 138 Level 2 protection on knuckles and fingers
- Reinforced TP-X® index finger and thumb saddle
- MudGrip+ palm: Synthetic leather with abrasion resistant PVC dots
- Elastic cuff with Velcro® closure for a secure fit, Pull tab loop

	Rig Lizard 2038
Article No.	60681
Standard	EN 388: 2016 (4 X 4 3 B P), 407 (X2 XXXX)
Colour	red/yellow
Sizes	6/XS through 12/3XL
Order quantity multiples	1 PR

# Impact Series

NEW



60682

NEW



60986



60670

	X 2 X X X X	4 X 4 3 C P	
	<b>ANSI/ISEA CUT</b>	<b>GRAM SCORE</b>	<b>ANSI/ISEA PUNCTURE</b>
	<b>A3</b>	<b>1074</b>	<b>4</b>
	<b>ANSI/ISEA 138</b>		
	<b>2</b>		

	X 2 X X X X	4 X 4 3 E P	
	<b>ANSI/ISEA CUT</b>	<b>GRAM SCORE</b>	<b>ANSI/ISEA PUNCTURE</b>
	<b>A6</b>	<b>3472</b>	<b>4</b>
	<b>ANSI/ISEA 138</b>		
	<b>2</b>		

	4 X 2 1 F P		
	<b>ANSI/ISEA CUT</b>	<b>GRAM SCORE</b>	<b>ANSI/ISEA PUNCTURE</b>
	<b>A8</b>	<b>5486</b>	<b>2</b>
	<b>ANSI/ISEA 138</b>		
	<b>1</b>		

## 2021X

Article No. 60670

### Rig Lizard®

- Back-of-hand IR-X® Impact Exoskeleton™ with high-flex design provides ANSI/ISEA 138 Level 1 protection on knuckles and fingers
- Additional IR-X® guard between thumb and index finger
- Durable TP-X® palm with reinforced stitching
- SlipFit® cuff with pull tab
- Protected by patents and patents pending

	Rig Lizard® 2021X
<b>Article No.</b>	60670
<b>Standard</b>	EN 388:2016 (4 X 4 3 C P), EN 407 (X 2 X X X X)
<b>Colour</b>	yellow/black/red
<b>Sizes</b>	6/XS through 12/3XL
<b>Order quantity multiples</b>	1 PR

## 2039

Article No. 60682

### Rig Lizard 2039

- Back-of-hand sewn-on IR-X® Impact Exoskeleton™ with high-flex design provides ANSI/ISEA 138 Level 2 protection on knuckles and fingers
- Reinforced TP-X® index finger and thumb saddle
- MudGrip+ palm: Synthetic leather with abrasion resistant PVC dots
- Elastic cuff with Velcro® closure for a secure fit, Pull tab loop

	Rig Lizard 2039
<b>Article No.</b>	60682
<b>Standard</b>	EN 388:2016 (4 X 4 3 E P), 407 (X 2 X X X X)
<b>Colour</b>	red/yellow
<b>Sizes</b>	6/XS through 12/3XL
<b>Order quantity multiples</b>	1 PR

## 4026

Artikel-Nr. 60986

### Chrome 4026

- SuperFabric® brand materials provide industry-leading cut resistance (interior layer)
- Back-of-hand impact guards provide ANSI/ISEA 138 Level 1 protection on knuckles and fingers
- Synthetic leather palm with abrasion-resistant PVC dots
- Hi-vis color and reflective tape on back-of-hand
- Elastic cuff with Velcro® closure for a secure fit

	Chrome 4026
<b>Article No.</b>	60986
<b>Standard</b>	EN 388:2016 (4 X 2 1 F P)
<b>Colour</b>	black/neon-yellow
<b>Sizes</b>	6/XS through 12/3XL
<b>Order quantity multiples</b>	1 PR

# Safety Gloves

## Overview

Art. no.	Art. code	Sizes	Colour	Page
60027	uvex athletic lite	6 to 11	blue, anthracite	22
60028	uvex athletic allround	6 to 11	grey, anthracite	21
60030	uvex athletic D5 XP	6 to 11	grey, anthracite	43
60033	uvex athletic lite dry	6 to 12	blue, anthracite	22
60036	uvex athletic B XP	6 to 12	grey, anthracite	42
60037	uvex athletic C XP	6 to 12	grey, anthracite	42
60038	uvex phynomic airLite A ESD	6 to 12	black	16
60040	uvex phynomic lite	5 to 12	grey, grey	20
60041	uvex phynomic lite w	5 to 12	white, white	20
60049	uvex phynomic allround	5 to 12	grey, black	17
60050	uvex phynomic foam	5 to 12	white, grey	17
60054	uvex phynomic x-foam HV	6 to 12	orange, grey	18
60060	uvex phynomic wet	6 to 12	blue, anthracite	18
60061	uvex phynomic wet plus	6 to 12	blue, anthracite	18
60062	uvex phynomic pro	6 to 12	blue, anthracite	19
60064	uvex phynomic pro 2	6 to 12	blue, anthracite	19
60070	uvex phynomic XG	6 to 12	black, black	17
60078	uvex phynomic airLite B ESD	6 to 12	light blue	40
60080	uvex phynomic C3	6 to 12	sky blue	41
60081	uvex phynomic C5	6 to 12	blue, grey	41
60084	uvex phynomic airLite C ESD	6 to 12	light blue	41
60090	uvex BambooTwinflex®	6 to 12	green, black	35
60119	uvex profapren CF33	7 to 10	dark blue	55
60122	uvex profastrong NF33	7 to 11	green	55
60135	uvex unigrip 6620	7 to 10	white, blue	25
60147	uvex profi ergo ENB20A	6 to 11	white, orange	26
60148	uvex profi ergo ENB20	6 to 10	white, orange	26
60150	uvex contact ergo	6 to 10	white, orange	26
60179	uvex k-basic extra 6658	8, 10, 12	yellow	57
60166	uvex u-fit ft	XS to XL	blue	29
60188	uvex u-chem 3500	7 to 11	orange	51
60190	uvex rubiflex S NB80S	9 to 11	green	48
60191	uvex rubiflex S NB80SZ	9 to 11	green	48
60202	uvex NK4022	9 to 10	orange	29
60208	uvex profi ergo XG20	6 to 11	white, orange, black	27
60210	uvex unidur 6641	6 to 11	white, grey	44
60213	uvex NK2722	9 to 10	orange	29
60224	uvex rubiflex S NB35B	7 to 11	blue	49
60238	uvex unigrip 6624	7 to 10	grey, red	25
60248	uvex unipur 6639	6 to 11	black, black	24
60271	uvex rubiflex S NB27B	7 to 11	blue	49
60276	uvex rubipor XS2001	6 to 10	white, white	21
60278	uvex unilite 7710F			28
60314	uvex unidur 6643	7 to 10	mottled grey, black	45
60316	uvex rubipor XS5001B	6 to 10	white, blue	21
60321	uvex unipur 6634	7 to 10	grey, black	23
6047900	uvex glove clip	-	black	27
60491	uvex C500 sleeve	M, L	lime	37
60492	uvex C500 wet	7 to 11	lime, anthracite	38
60494	uvex C500 foam	7 to 11	lime, anthracite	38
60496	uvex C500 wet plus	7 to 11	lime, anthracite	37
60497	uvex C500	7 to 11	lime	37
60498	uvex C500 M foam	7 to 11	lime, black, anthracite	36
60499	uvex C500 dry	7 to 11	lime, anthracite	38
60516	uvex unidur 6649	7 to 11	mottled grey, grey	44
60535	uvex protector chemical NK2725B	9 to 10	blue	54
60536	uvex protector chemical NK4025B	9 to 10	blue	54
60542	uvex C300 wet	7 to 11	anthracite	39
60544	uvex C300 foam	7 to 11	anthracite	39
60549	uvex C300 dry	7 to 11	anthracite	39
60556	uvex unipur carbon	6 to 10	grey	25
60557	uvex rubiflex S XG35B	7 to 11	blue, black	49
60558	uvex profi ergo XG20A	6 to 11	white, orange, black	27
60560	uvex rubiflex S XG27B	7 to 11	blue, black	49
60573	uvex unilite 6605	6 to 11	black, black	23
60585	uvex unilite 7700	7 to 11	grey, black	23
60587	uvex unipur carbon FT	6 to 10	grey	25
60591	uvex unilite thermo plus cut C	7 to 11	lime, black	30
60592	uvex unilite thermo plus	7 to 11	black	30
60593	uvex unilite thermo	7 to 11	black	30

Art. no.	Art. code	Sizes	Colour	Page
60595	uvex profatherm XB40	11	white	29
60596	uvex u-fit	S to XL	blue	57
60597	uvex u-fit lite	S to XL	indigo blue	57
60600	uvex C500 XG	7 to 11	lime, anthracite	37
60604	uvex D500 foam	7 to 11	lime, anthracite	36
60838	uvex arc protect g1	7 to 11	anthracite	31
60840	uvex power protect V1000	7 to 11	red	31
60932	uvex unidur 6648	6 to 11	white, black	44
60938	uvex unidur 6659 foam	6 to 11	mottled grey, black	45
60942	uvex unilite thermo HD	8 to 11	orange, black	30
60943	uvex unipur 6630	6 to 11	white	24
60944	uvex unipur 6631	6 to 11	grey	24
60945	uvex compact NB27H	10	white, blue	28
60946	uvex compact NB27E	9 to 10	white, blue	28
60949	uvex profabutyl B-05R	7 to 11	black	53
60954	uvex rubiflex ESD NB35A	6 to 11	black	52
60957	uvex profaviton BV-06	8 to 11	black	53
60962	uvex u-strong N2000	S to XXL	blue	57
60968	uvex u-chem 3100	8 to 11	black	50
60971	uvex u-chem 3300	7 to 11	blue	50
60972	uvex u-chem 3200	7 to 11	petrol, black	50
60973	uvex unidur sleeve C	M, L	mottled grey	43
60974	uvex unidur sleeve C TL	M, L	mottled grey	43
89636	uvex rubiflex NB27	7 to 11	orange	28
89646	uvex rubiflex S NB27S	8 to 11	green	48
89647	uvex rubiflex S NB60S	9 to 11	green	48
89651	uvex rubiflex S NB60SZ	9 to 11	green	48
98891	uvex rubiflex S NB35S	8 to 11	green	48
98902	uvex rubiflex S NB40S	8 to 11	green	48

Art. no.	Art. code	Sizes	Colour	Page
60005	PointGuard® Ultra 90931	6 to 12	black	63
60010	ThornArmor 3092	5 to 11	brown/black	66
60609	Chrome SLT 4070	6 to 12	orange/grey	67
60614	Helix® 2082	7 to 11	green mottled/black	64
60638	PointGuard® Ultra 9032	7 to 10	yellow/blue	62
60642	Helix® 1095	6 to 12	grey/black/yellow	68
60646	Thin Lizzie™ Thermal 2099	6 to 10	yellow/black/red	67
60648	Thin Lizzie™ 2090X	5 to 12	grey/yellow	70
60650	Thin Lizzie™ 2095	5 to 12	blue/black/yellow	70
60651	Rig Lizard 7101	6 to 12	yellow/blue	68
60652	Thin Lizzie™ Fluid 7102	6 to 12	blue/yellow	68
60655	Chrome SLT® 4062	6 to 12	beige	65
60659	Helix® 2065	6 to 12	blue/black	64
60660	Helix® 2076	5 to 13	blue mottled/black	64
60661	Helix® 2062	6 to 12	yellow/black	65
60662	Helix® 3000	6 to 12	yellow/black	69
60665	Helix® 3003	7 to 10	black/black	69
60666	Helix® 3007	6 to 12	red/yellow/black/grey	69
60668	Helix® 3033	6 to 11	mottled blue	65
60670	Rig Lizard® 2021X	6 to 12	yellow/black/red	71
60672	PointGuard® Ultra 4043U	7 to 10	black	63
60673	Chrome 4023M	7 to 12	grey/green	66
60681	Rig Lizard 2038	6 to 12	red/yellow	70
60682	Rig Lizard 2039	6 to 12	red/yellow	71
60981	SharpsMaster II® 9014	6 to 10	white/orange	62
60982	Armschutz AG8TW	7 to 10	black	62
60983	Hercules® NSR 3041	7 to 11	black	63
60984	9000 Series 9013	7 to 11	mottled grey/black	67
60985	Armschutz AG10009S	6 to 12	black/neon-yellow	66
60986	Chrome 4026	6 to 12	black/neon-yellow	71



# uvex

**uvex** uvex Bamboo TwinFlex® D xg

**GLOBAL**

**PRODUCTION**

**FEATURES**

**uvex**  
Bamboo TwinFlex® D xg  
MADE IN GERMANY  
uvex safety

09.22 · Rights of technical changes reserved.  
© 2022 – UVEX SAFETY Gloves GmbH & Co. KG



**Download now  
in the App Store!**

**Explore the new  
Augmented Reality App!**

UVEX ARBEITSSCHUTZ GMBH  
Wuerzburger Straße 181-189  
90766 Fuerth  
GERMANY

**T** +49 911 9736-0  
**F** +49 911 9736-1760  
**E** [safety@uvex.de](mailto:safety@uvex.de)  
**I** [uvex-safety.com](http://uvex-safety.com)

protecting people